

## Pressure microregulators - Series T

Product code: T108-R11

Datasheet creation date: 10/03/2025 01:49

Check the most updated document online [click here](#)



### TECHNICAL DATA

Mod.	T108-R11
U	G1/8

## Pressure microregulators - Series T

Product code: T108-R11

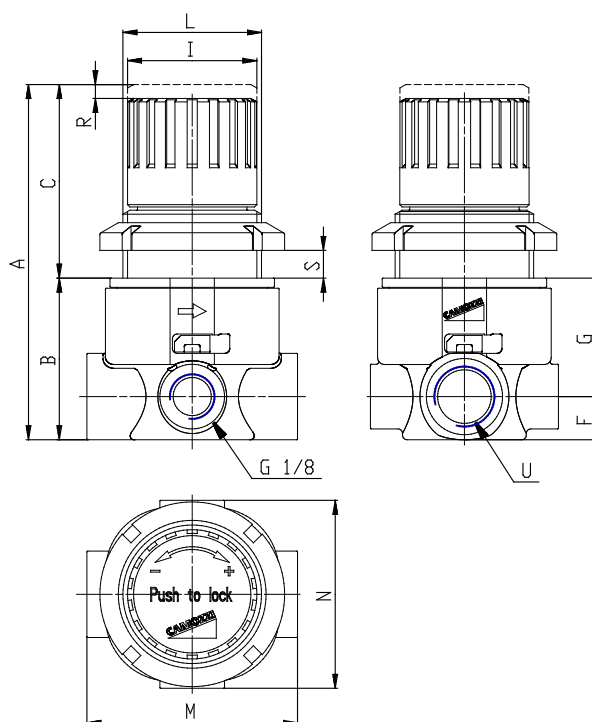

### DIMENSIONS

<b>A (mm)</b>	77
<b>B (mm)</b>	35
<b>C (mm)</b>	42
<b>F (mm)</b>	9.5
<b>G (mm)</b>	25.5
<b>I (mm)</b>	28
<b>L</b>	M30x1.5
<b>M (mm)</b>	46
<b>N (mm)</b>	41
<b>R (mm)</b>	3