

Pressure microregulators - Series T

Product code: T108-R21

Datasheet creation date: 10/03/2025 01:49

Check the most updated document online [click here](#)



TECHNICAL DATA

Mod.	T108-R21
U	G1/8

Pressure microregulators - Series T

Product code: T108-R21

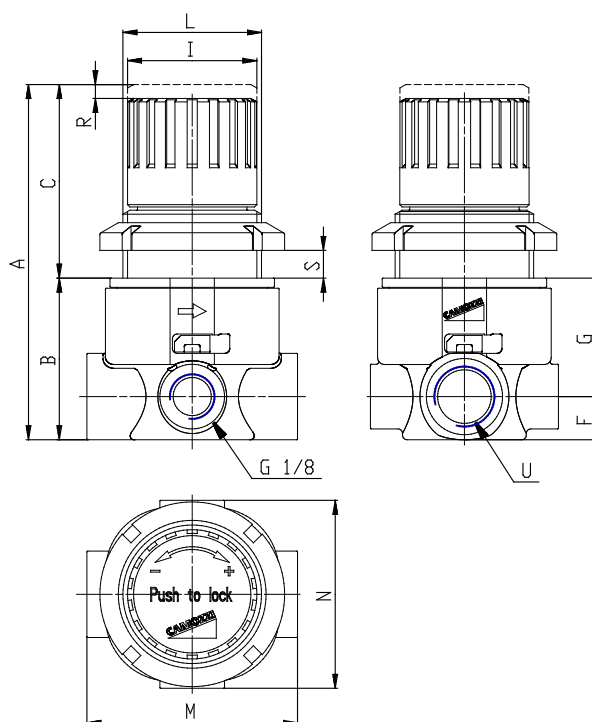

DIMENSIONS

A (mm)	77
B (mm)	35
C (mm)	42
F (mm)	9.5
G (mm)	25.5
I (mm)	28
L	M30x1.5
M (mm)	46
N (mm)	41
R (mm)	3