

Pressure microregulators - Series T

Product code: T108-R71

Datasheet creation date: 10/03/2025 01:49

Check the most updated document online [click here](#)



TECHNICAL DATA

| | |
|------|----------|
| Mod. | T108-R71 |
| U | G1/8 |

Pressure microregulators - Series T

Product code: T108-R71

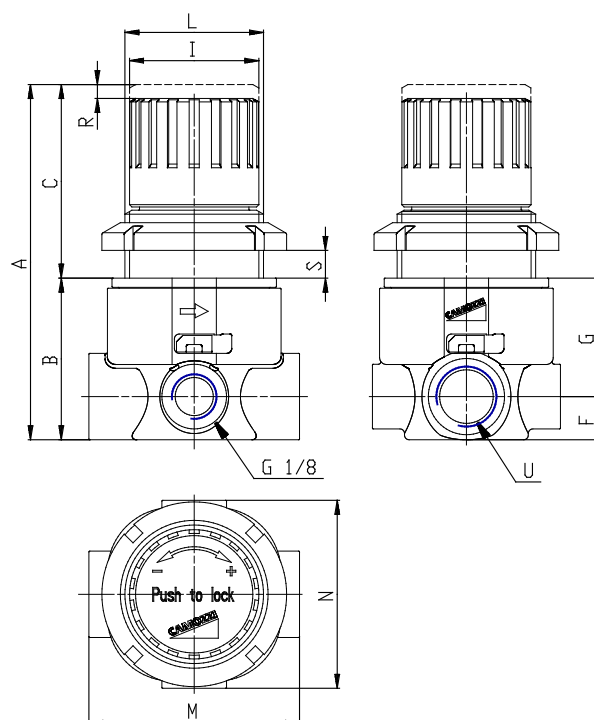

DIMENSIONS

| | |
|---------------|---------|
| A (mm) | 77 |
| B (mm) | 35 |
| C (mm) | 42 |
| F (mm) | 9.5 |
| G (mm) | 25.5 |
| I (mm) | 28 |
| L | M30x1.5 |
| M (mm) | 46 |
| N (mm) | 41 |
| R (mm) | 3 |