

Pressure microregulators - Series TC

Product code: TC1-R21-C-V-OX1

Datasheet creation date: 10/03/2025 01:49

Check the most updated document online [click here](#)



TECHNICAL DATA

Series	TC
SIZE	1
Regulator	R
WORKING PRESSURE	2= 0-2 bar
TYPE OF CONSTRUCTION	1 = without relieving
PORTS	C = Cartridge
SEALING	V= FKM
VERSIONS	OX1 = for oxygen (non-volatile residue lower than 550 mg/m ²)

Pressure microregulators - Series TC

Product code: TC1-R21-C-V-OX1

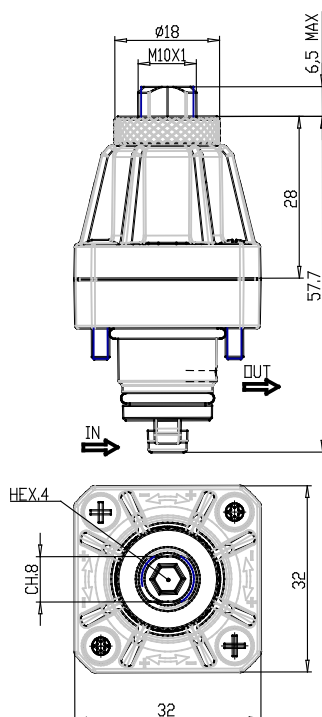

DIMENSIONS

Series	TC
SIZE	1
Regulator	R
WORKING PRESSURE	2= 0-2 bar
TYPE OF CONSTRUCTION	1 = without relieving
PORTS	C = Cartridge
SEALING	V= FKM
VERSIONS	OX1 = for oxygen (non-volatile residue lower than 550 mg/m ²)