

## Pressure microregulators - Series TC

Product code: TC1-R41-1/8-V-OX2

Datasheet creation date: 10/03/2025 01:49

Check the most updated document online [click here](#)



### TECHNICAL DATA

<b>Series</b>	TC
<b>SIZE</b>	1
<b>Regulator</b>	R
<b>WORKING PRESSURE</b>	4=0-4 bar
<b>TYPE OF CONSTRUCTION</b>	1 = without relieving
<b>PORTS</b>	1/8 = G1/8
<b>SEALING</b>	V= FKM
<b>VERSIONS</b>	OX2 = for oxygen (non-volatile residue lower than 33 mg/m <sup>2</sup> )

## Pressure microregulators - Series TC

Product code: TC1-R41-1/8-V-OX2

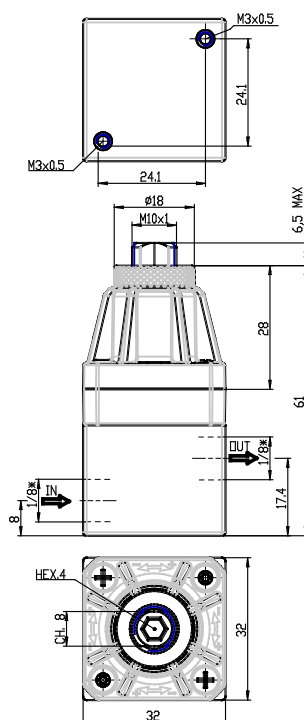

### DIMENSIONS

<b>Series</b>	TC
<b>SIZE</b>	1
<b>Regulator</b>	R
<b>WORKING PRESSURE</b>	4=0-4 bar
<b>TYPE OF CONSTRUCTION</b>	1 = without relieving
<b>PORTS</b>	1/8 = G1/8
<b>SEALING</b>	V= FKM
<b>VERSIONS</b>	OX2 = for oxygen (non-volatile residue lower than 33 mg/m <sup>2</sup> )