

Valves - Series TMCO

Product code: TMCO 974-1/4-6

Datasheet creation date: 10/03/2025 12:17

Check the most updated document online [click here](#)



TECHNICAL DATA

Mod.	TMCO 974-1/4-6
------	----------------

Valves - Series TMCO

Product code: TMCO 974-1/4-6

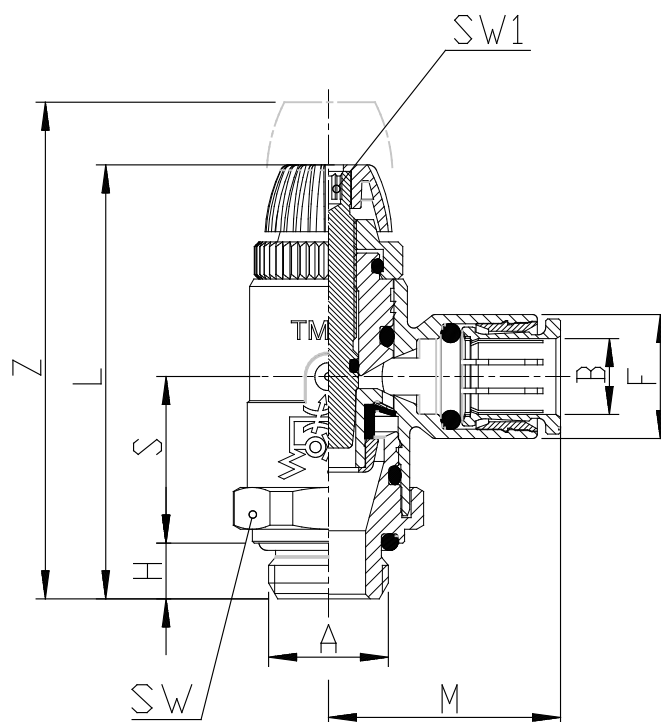

DIMENSIONS

A	G1/4
B (mm)	6
F (mm)	11.5
H (mm)	6
L (mm)	42.0
M (mm)	21.5
S (mm)	16.5
SW (mm)	17
SW1 (mm)	1.5
Z (mm)	49.0