

## Valves - Series TMCO

Product code: TMCO 976-1/4-8

Datasheet creation date: 10/03/2025 12:17

Check the most updated document online [click here](#)



### TECHNICAL DATA

Mod.	TMCO 976-1/4-8
------	----------------

## Valves - Series TMCO

Product code: TMCO 976-1/4-8

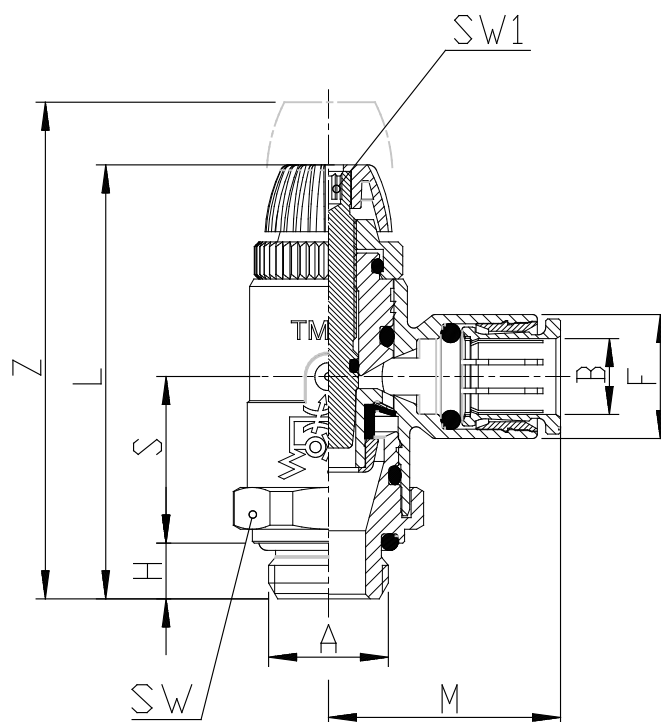

### DIMENSIONS

<b>A</b>	G1/4
<b>B (mm)</b>	8
<b>F (mm)</b>	13.5
<b>H (mm)</b>	6
<b>L (mm)</b>	46.5
<b>M (mm)</b>	25.0
<b>S (mm)</b>	18.0
<b>SW (mm)</b>	19
<b>SW1 (mm)</b>	2.5
<b>Z (mm)</b>	53.5