

Valves - Series TMCO

Product code: TMCO 976-3/8-8

Datasheet creation date: 10/03/2025 12:17

Check the most updated document online [click here](#)



TECHNICAL DATA

Mod.	TMCO 976-3/8-8
------	----------------

Valves - Series TMCO

Product code: TMCO 976-3/8-8

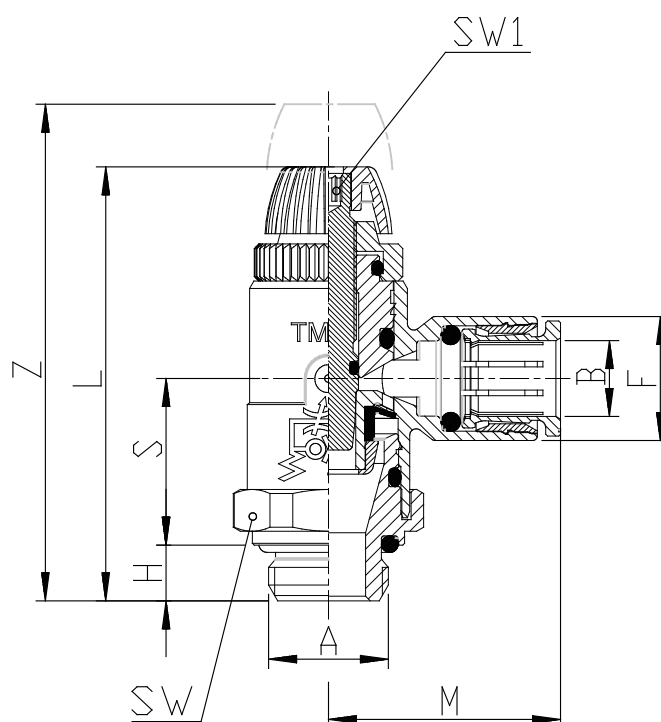

DIMENSIONS

A	G3/8
B (mm)	8
F (mm)	13.5
H (mm)	7
L (mm)	47.5
M (mm)	25.0
S (mm)	18.0
SW (mm)	20
SW1 (mm)	2.5
Z (mm)	54.5