

- Valves series TMCU

Product code: TMCU 06-06

Datasheet creation date: 10/03/2025 12:17

Check the most updated document online [click here](#)



TECHNICAL DATA

Mod.	TMCU 06-06
------	------------

- Valves series TMCU

Product code: TMCU 06-06

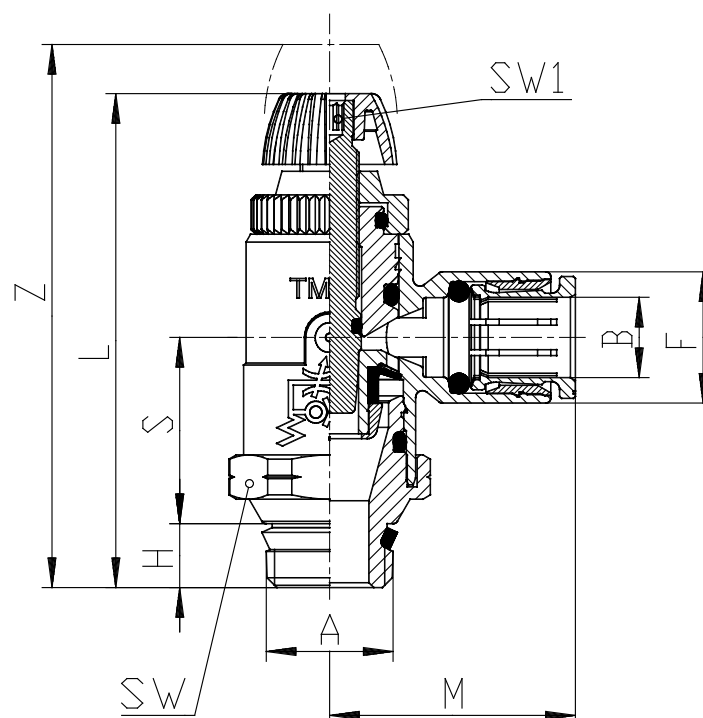

■ DIMENSIONS

A (mm)	3/8
B (NPTF) (INCH)	3/8
F (INCH)	0.630
H (INCH)	0.295
L (INCH)	2.008
M (INCH)	1.142
S (INCH)	0.728
SW (INCH)	0.945
SW1 (INCH)	0.098
Z (INCH)	2.323