

- Valves series TMCU

Product code: TMCU 53-02

Datasheet creation date: 10/03/2025 12:17

Check the most updated document online [click here](#)



TECHNICAL DATA

Mod.	TMCU 53-02
------	------------

- Valves series TMCU

Product code: TMCU 53-02

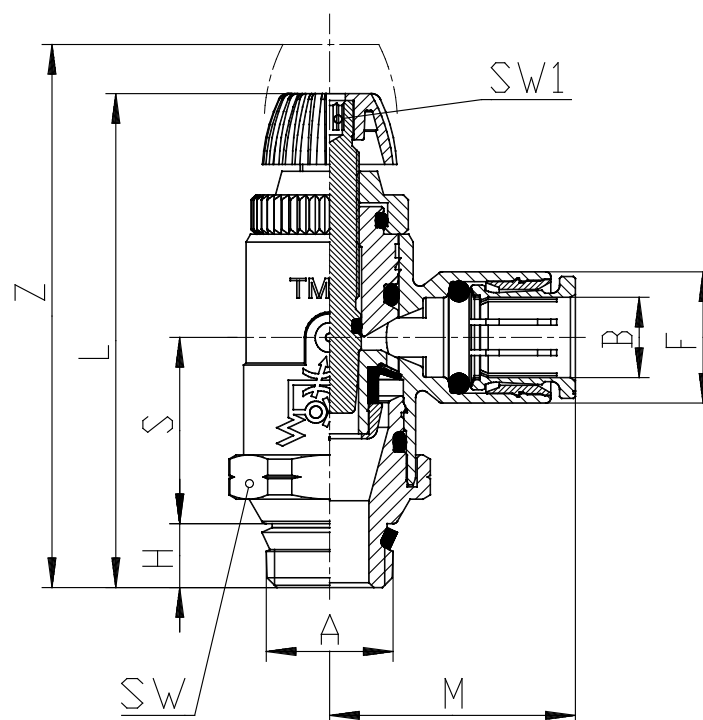

DIMENSIONS

A (mm)	1/8
B (NPTF) (INCH)	5/32
F (INCH)	0.453
H (INCH)	0.197
L (INCH)	1.654
M (INCH)	0.846
S (INCH)	0.709
SW (INCH)	0.630
SW1 (INCH)	0.059
Z (INCH)	1.929