

Centring sleeve - Mod. TR

Product code: TR-32-40

Datasheet creation date: 07/03/2025 15:58

Check the most updated document online [click here](#)



TECHNICAL DATA

Mod.	TR-32-40
------	----------

Centring sleeve - Mod. TR

Product code: TR-32-40

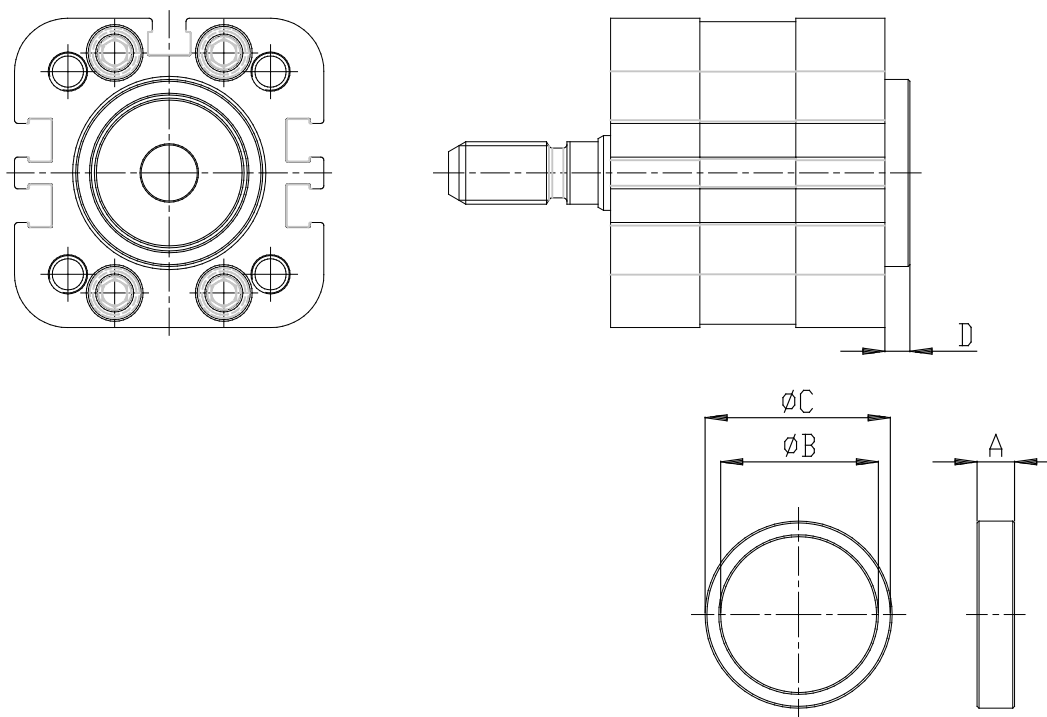

DIMENSIONS

A (mm)	6
B (mm)	30
C (mm)	35
D (mm)	4