

Centring sleeve - Mod. TR

Product code: TR-32-63

Datasheet creation date: 07/03/2025 15:58

Check the most updated document online [click here](#)



TECHNICAL DATA

Mod.	TR-32-63
------	----------

Centring sleeve - Mod. TR

Product code: TR-32-63

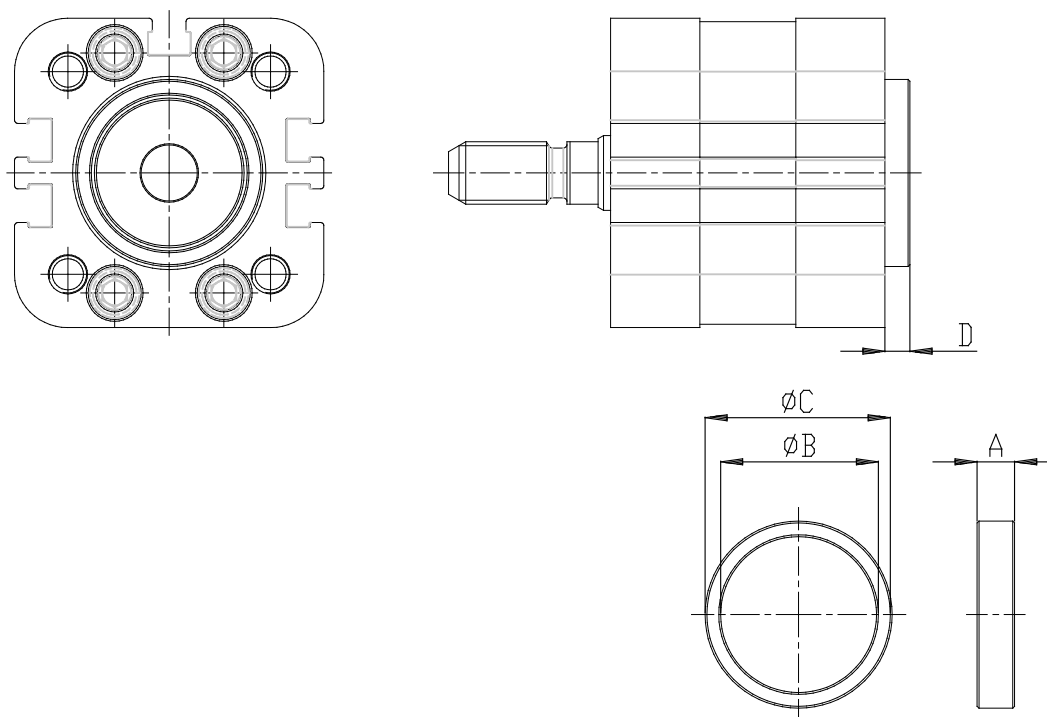

DIMENSIONS

A (mm)	7
B (mm)	40
C (mm)	45
D (mm)	5