

Basics ejectors - Series VEBL

Product code: VEBL-05H-T1

Datasheet creation date: 10/03/2025 00:23

Check the most updated document online [click here](#)



TECHNICAL DATA

Mod.	VEBL-05H-T1
------	-------------

Basics ejectors - Series VEBL

Product code: VEBL-05H-T1

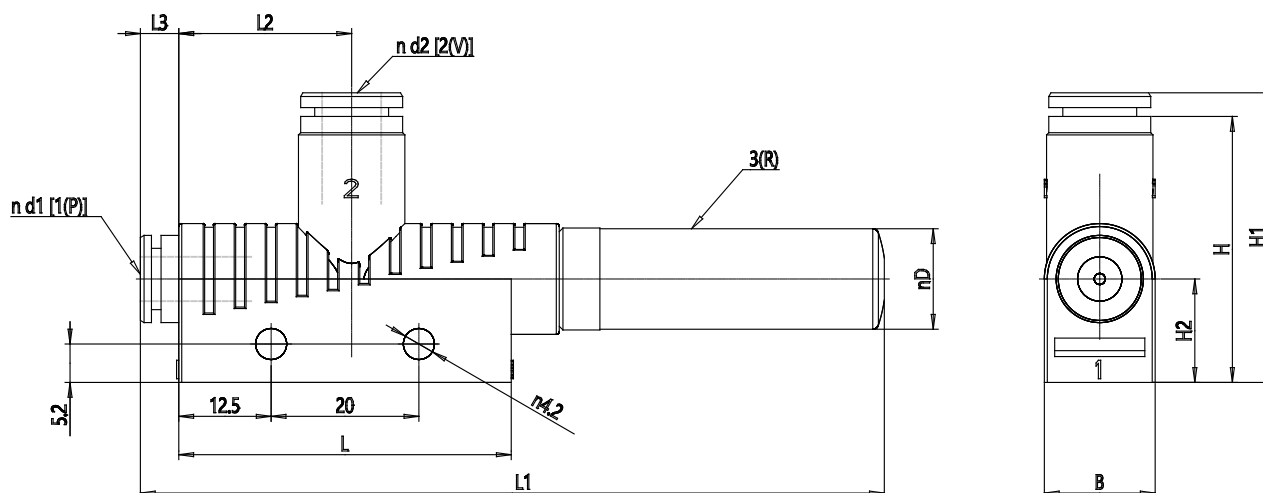

DIMENSIONS

B (mm)	10
D1 (mm)	4
D2 (mm)	4
D (mm)	9
H (mm)	26
H1 (mm)	28.0
H2 (mm)	12
L (mm)	45.0
L1 (mm)	71
L2 (mm)	18.0
L3 (mm)	2.0