

Basics ejectors - Series VEBL

Product code: VEBL-10H-T2

Datasheet creation date: 10/03/2025 00:22

Check the most updated document online [click here](#)



TECHNICAL DATA

Mod.	VEBL-10H-T2
------	-------------

Basics ejectors - Series VEBL

Product code: VEBL-10H-T2

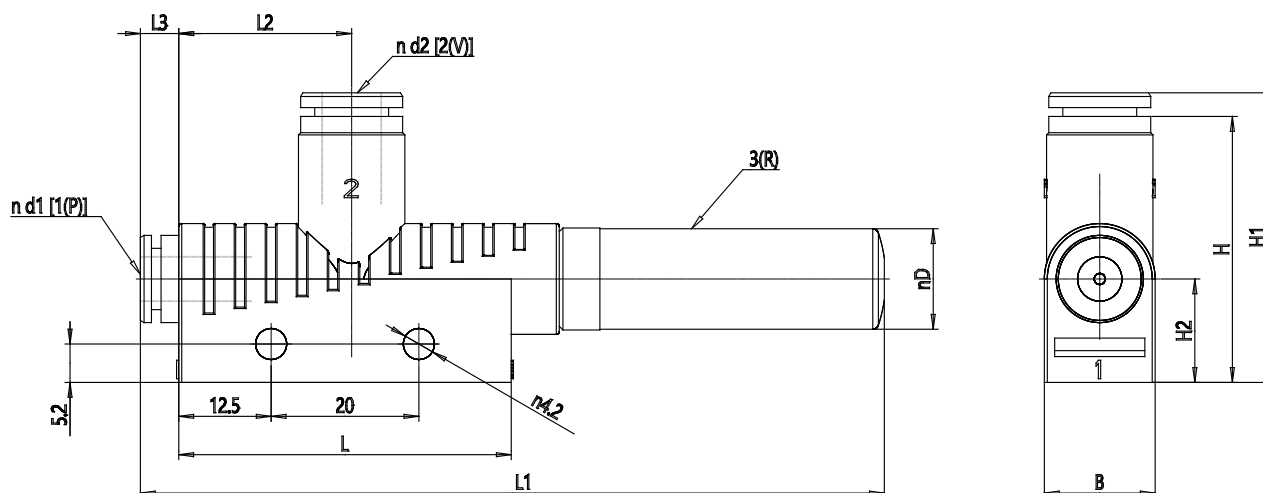

DIMENSIONS

B (mm)	15
D1 (mm)	6
D2 (mm)	8
D (mm)	14
H (mm)	34
H1 (mm)	40.0
H2 (mm)	14
L (mm)	51.5
L1 (mm)	97
L2 (mm)	22.0
L3 (mm)	5.5