

Compact ejectors - Series VES

Product code: VES-15NO-S

Datasheet creation date: 10/03/2025 00:25

Check the most updated document online [click here](#)



TECHNICAL DATA

Series	VES
Venturi nozzle diameter	15 = 1.5 mm
Valve type	NO = with vacuum at rest position
Version	S = saving of compressed air

Compact ejectors - Series VES

Product code: VES-15NO-S

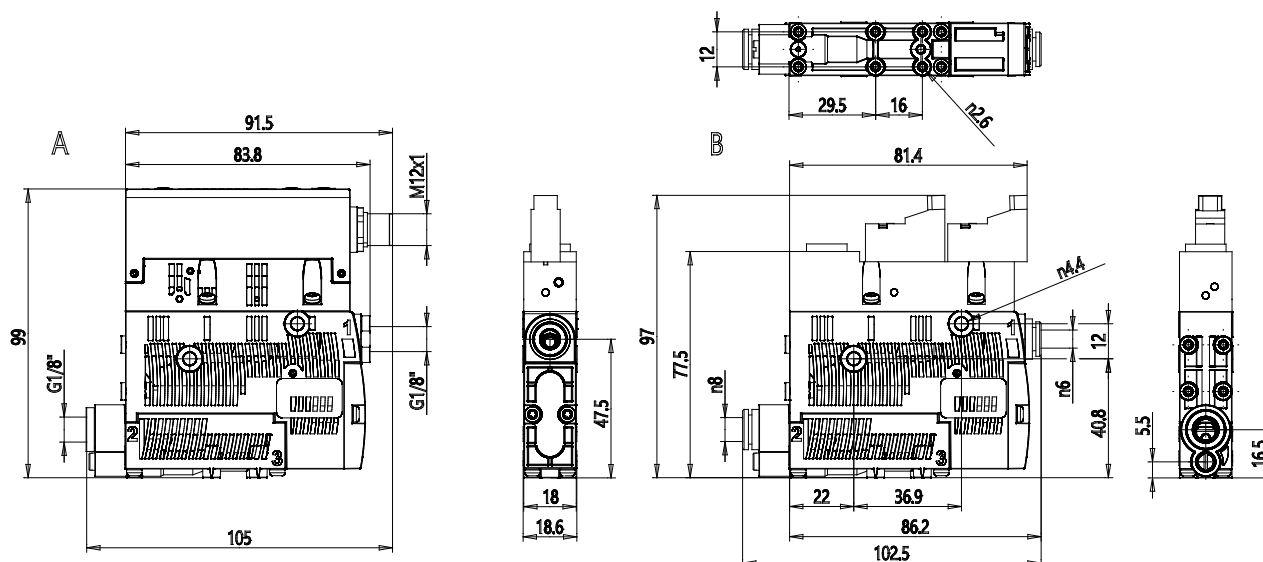

DIMENSIONS

Nozzle Ø (mm)	1.5
Degree of discharge (%)	85
Max suction capacity ((l/min))	65.5
Consumption ((l/min))	98
Exhaust consumption ((m ³ /h))	7.2
Noise in suction ([db(A)])	65
Noise in mantaining ([db(A)])	77
Working pressure (bar)	3 - 6
Int diameter compressed air tube (mm)	4
Int diameter for vacuum tube (mm)	6
Delta temperature (°C)	0 / 50°
L (mm)	93
L1 (mm)	106