

Series VPCF round flat suction pads - Series VPCF

Product code: VPCF-0250E-1/8F

Datasheet creation date: 10/03/2025 12:20

Check the most updated document online [click here](#)



TECHNICAL DATA

Series	VP
Shape	C = circular
Version	F = flat
Diameters	0250 = 25 mm
Materials	E = elastodur
Thread size	G1/8
Thread type	F = female

Series VPCF round flat suction pads - Series VPCF

Product code: VPCF-0250E-1/8F

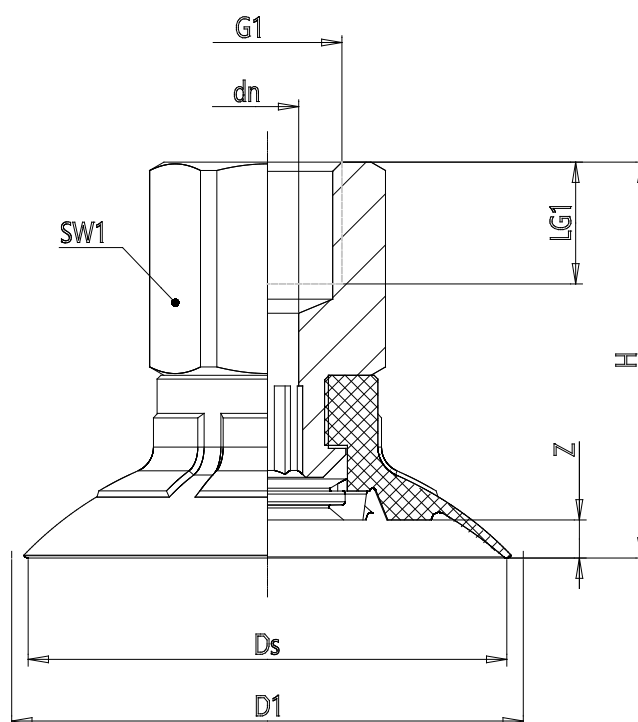

DIMENSIONS

DN (mm)	4.1
DS (mm)	26.4
D1 (mm)	28.0
G1	G1/8
H (mm)	25.0
HM (mm)	17.0
HF (mm)	25
LG1 (mm)	8.0
SW1 (mm)	14
Z (mm)	2.0
Suction pad	VPCF 0250E
Nipple	NPS-G-1/8