

Series VPCF round flat suction pads - Series VPCF

Product code: VPCF-0300E-1/8M

Datasheet creation date: 10/03/2025 12:20

Check the most updated document online [click here](#)



TECHNICAL DATA

Series	VP
Shape	C = circular
Version	F = flat
Diameters	0300 = 30 mm
Materials	E = elastodur
Thread size	G1/8
Thread type	M = male

Series VPCF round flat suction pads - Series VPCF

Product code: VPCF-0300E-1/8M

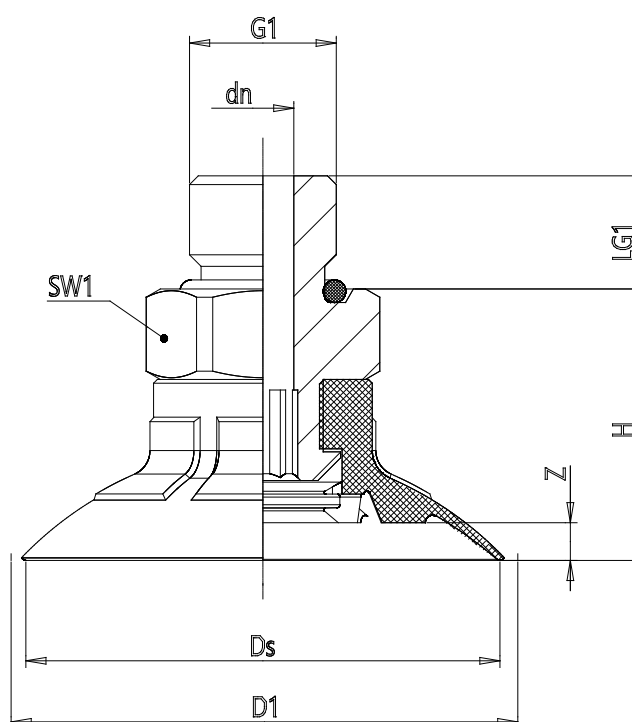

DIMENSIONS

DN (mm)	4.1
DS (mm)	31.4
D1 (mm)	33.6
G1	G1/8
H (mm)	18.0
HM (mm)	18.0
HF (mm)	26
LG1 (mm)	7.5
SW1 (mm)	14
Z (mm)	2.5
Suction pad	VPCF 0300E
Nipple	NPS-G-1/8