

Series VPCF round flat suction pads - Series VPCF

Product code: VPCF-0400E-1/4M

Datasheet creation date: 10/03/2025 12:21

Check the most updated document online [click here](#)



TECHNICAL DATA

Series	VP
Shape	C = circular
Version	F = flat
Diameters	0400 = 40 mm
Materials	E = elastodur
Thread size	G1/4
Thread type	M = male

Series VPCF round flat suction pads - Series VPCF

Product code: VPCF-0400E-1/4M

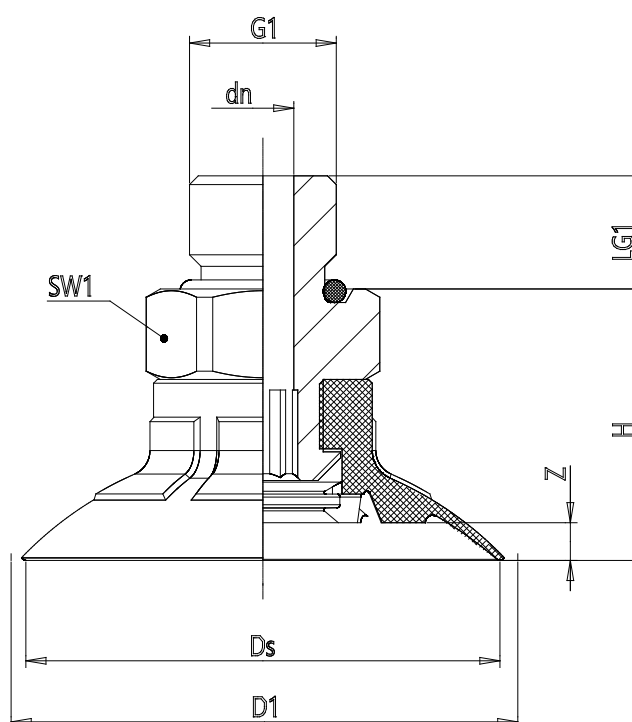

DIMENSIONS

DN (mm)	6.1
DS (mm)	41.4
D1 (mm)	43.7
G1	G1/4
H (mm)	23.0
HM (mm)	23.0
HF (mm)	33
LG1 (mm)	10.0
SW1 (mm)	17
Z (mm)	2.5
Suction pad	VPCF 0400E
Nipple	NPS-A-1/4