

Series VPCF round flat suction pads - Series VPCF

Product code: VPCF-0500E-1/4F

Datasheet creation date: 10/03/2025 12:21

Check the most updated document online [click here](#)



TECHNICAL DATA

Series	VP
Shape	C = circular
Version	F = flat
Diameters	0500 = 50 mm
Materials	E = elastodur
Thread size	G1/4
Thread type	F = female

Series VPCF round flat suction pads - Series VPCF

Product code: VPCF-0500E-1/4F

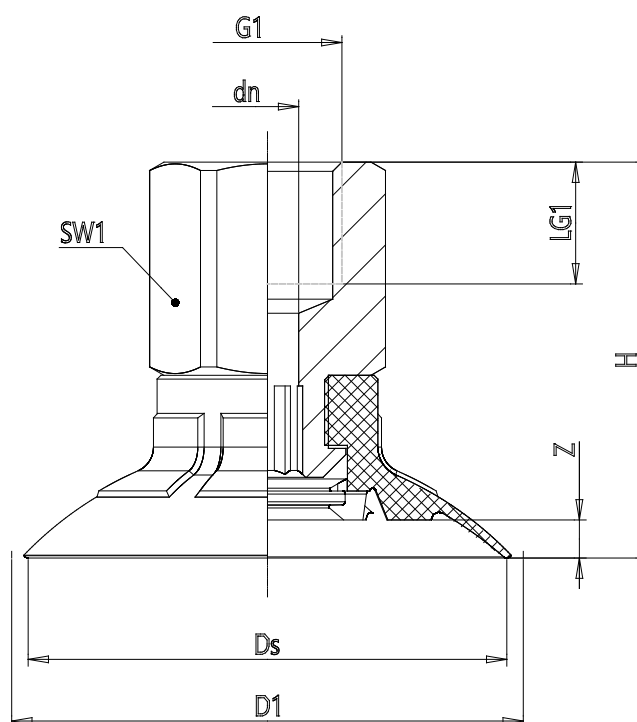

DIMENSIONS

DN (mm)	6.1
DS (mm)	51.4
D1 (mm)	53.9
G1	G1/4
H (mm)	34.0
HM (mm)	24.0
HF (mm)	34
LG1 (mm)	12.0
SW1 (mm)	17
Z (mm)	3.5
Suction pad	VPCF 0650E
Nipple	NPS-A-1/4