

Series VPCL round bellow suction pads - Series VPCL

Product code: VPCL-0500E-1/4M

Datasheet creation date: 10/03/2025 12:23

Check the most updated document online [click here](#)



TECHNICAL DATA

Series	VP
Shape	C = circular
Version	L = 1.5 bends
Diameters	0500 =50 mm
Materials	E = elastodur
Thread size	G1/4
Thread type	M = male

Series VPCL round bellow suction pads - Series VPCL

Product code: VPCL-0500E-1/4M

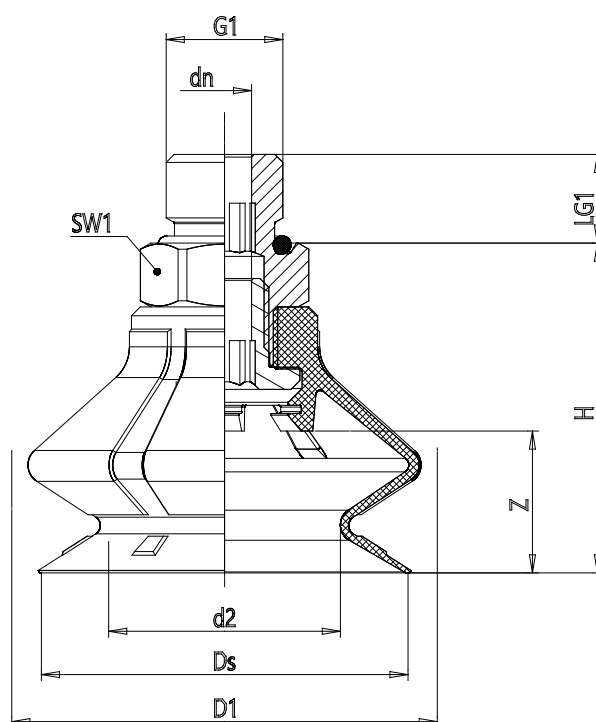

DIMENSIONS

DN (mm)	6.1
DS (mm)	51.4
D1 (mm)	58.4
G1	G1/4
H (mm)	40
HM (mm)	40
HF (mm)	50
LG1 (mm)	10.0
SW1 (mm)	17
Z (mm)	18
Suction pad	VPCL 0650E
Nipple	NPS-A-1/4