

Quick exhaust valves - Series VSC

Product code: VSC 544-1/4

Datasheet creation date: 10/03/2025 11:10

Check the most updated document online [click here](#)



TECHNICAL DATA

Mod.	VSC 544-1/4
SW (mm)	17
Medium inlet flow rate 1 > 2 at 6 bar, ΔP 1 bar] (NI/min)	860
Medium inlet flow rate 2 > 3 at 6 bar, ΔP 1 bar] (NI/min)	1600
Min. operating pressure (bar) (bar)	0,3

Quick exhaust valves - Series VSC

Product code: VSC 544-1/4

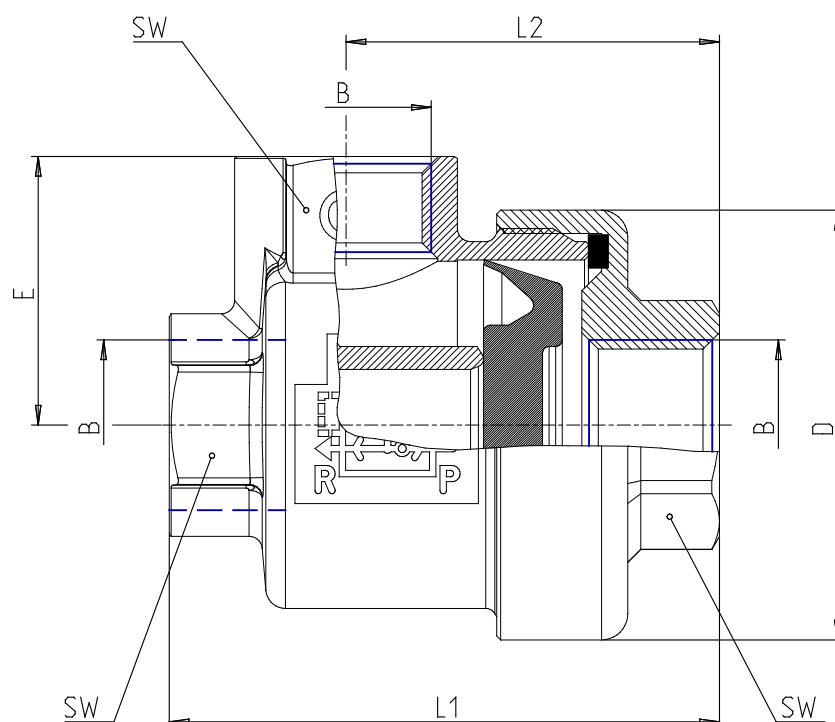

DIMENSIONS

D (mm)	33
E (mm)	20.5
L1 (mm)	42.0
L2 (mm)	28.5