

## flat suction pads (oval) - Series VTOF

Product code: VTOF-0900-300S-1/4M

Datasheet creation date: 10/03/2025 12:19

Check the most updated document online [click here](#)



### TECHNICAL DATA

<b>Series</b>	VTOF
<b>Materials</b>	S = Silicone
<b>Thread size</b>	G1/4
<b>Thread type</b>	M = male

## flat suction pads (oval) - Series VTOF

Product code: VTOF-0900-300S-1/4M

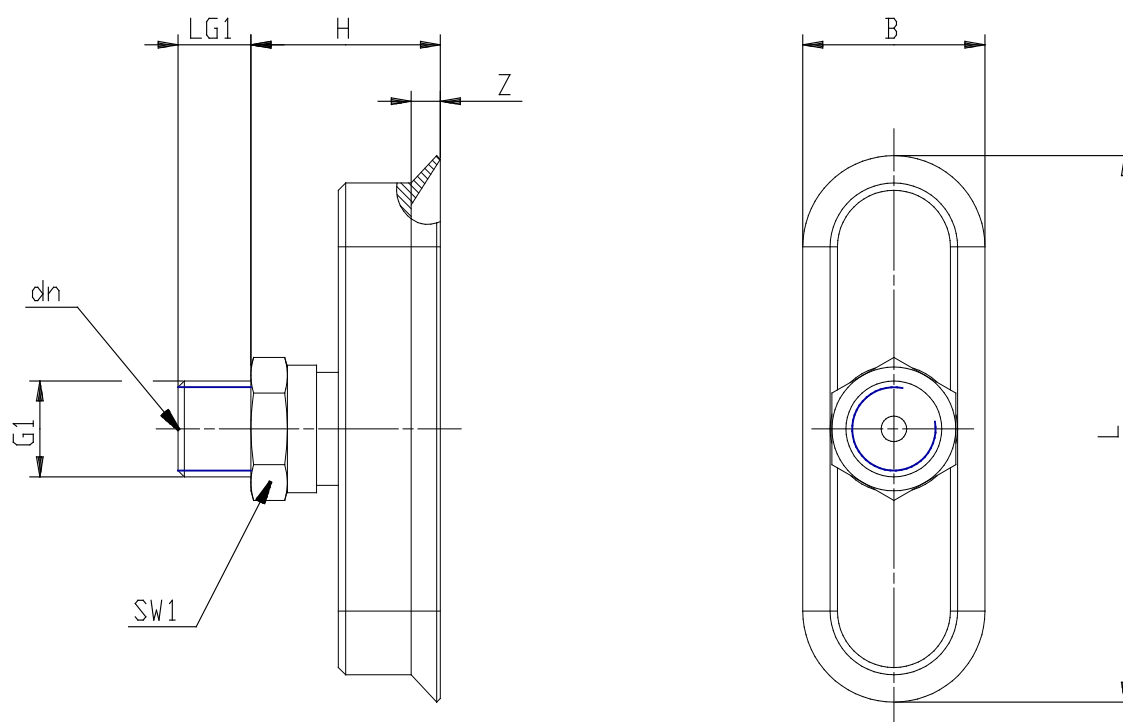

### DIMENSIONS

<b>DN (mm)</b>	3.5
<b>G1</b>	G1/4M
<b>H (mm)</b>	26
<b>L (mm)</b>	90
<b>LG1 (mm)</b>	10.0
<b>SW1 (mm)</b>	17
<b>Z (mm)</b>	3.5
<b>Suction pad</b>	VTOF-0900-300*
<b>Nipple</b>	NPV-Q-1/4-M