

Direct operated solenoid valves - Series W

Product code: W000-305-W23

Datasheet creation date: 10/03/2025 11:43

Check the most updated document online [click here](#)



TECHNICAL DATA

Series	W
Body execution	0 = interface
Number of seats	00 = ISO 15218 interface
Number of ways - Functions	3 = 3/2 way - NC
Valve connections	0 = ISO 15218 interface
Orifice diameter	5 = Ø 1.1 mm
Materials	W = PBT body - NBR - FKM - PU seals
Electrical connection	2 = 12 V DC - 2 W (1 W only for NC - Ø 0.8 mm version)
Voltage - Absorbed power	3 = 24 V DC - 2 W
Fixing	= fixing screws for metal
Options	= Standard

Direct operated solenoid valves - Series W

Product code: W000-305-W23

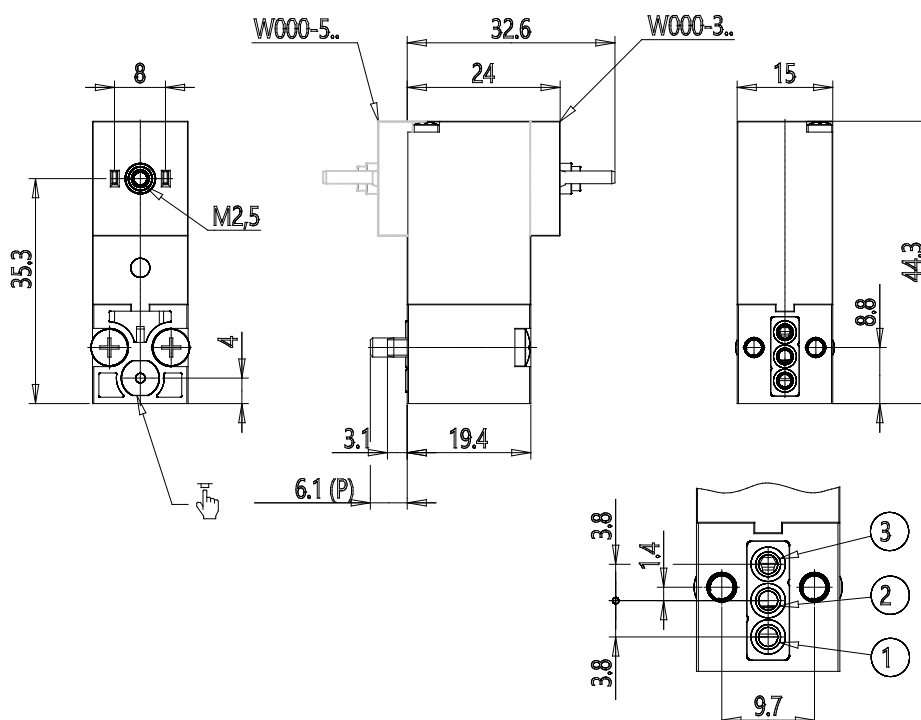

DIMENSIONS

Series	W
Body execution	0 = interface
Number of seats	00 = ISO 15218 interface
Number of ways - Functions	3 = 3/2 way - NC
Valve connections	0 = ISO 15218 interface
Orifice diameter	5 = \varnothing 1.1 mm
Materials	W = PBT body - NBR - FKM - PU seals
Electrical connection	2 = 12 V DC - 2 W (1 W only for NC - \varnothing 0.8 mm version)
Voltage - Absorbed power	3 = 24 V DC - 2 W
Fixing	= fixing screws for metal
Options	= Standard