

## Direct operated solenoid valves - Series W

Product code: W000-305-W24

Datasheet creation date: 10/03/2025 11:43

Check the most updated document online [click here](#)



### TECHNICAL DATA

<b>Series</b>	W
<b>Body execution</b>	0 = interface
<b>Number of seats</b>	00 = ISO 15218 interface
<b>Number of ways - Functions</b>	3 = 3/2 way - NC
<b>Valve connections</b>	0 = ISO 15218 interface
<b>Orifice diameter</b>	5 = Ø 1.1 mm
<b>Materials</b>	W = PBT body - NBR - FKM - PU seals
<b>Electrical connection</b>	2 = 12 V DC - 2 W (1 W only for NC - Ø 0.8 mm version)
<b>Voltage - Absorbed power</b>	4 = 48 V DC - 2 W
<b>Fixing</b>	= fixing screws for metal
<b>Options</b>	= Standard

## Direct operated solenoid valves - Series W

Product code: W000-305-W24

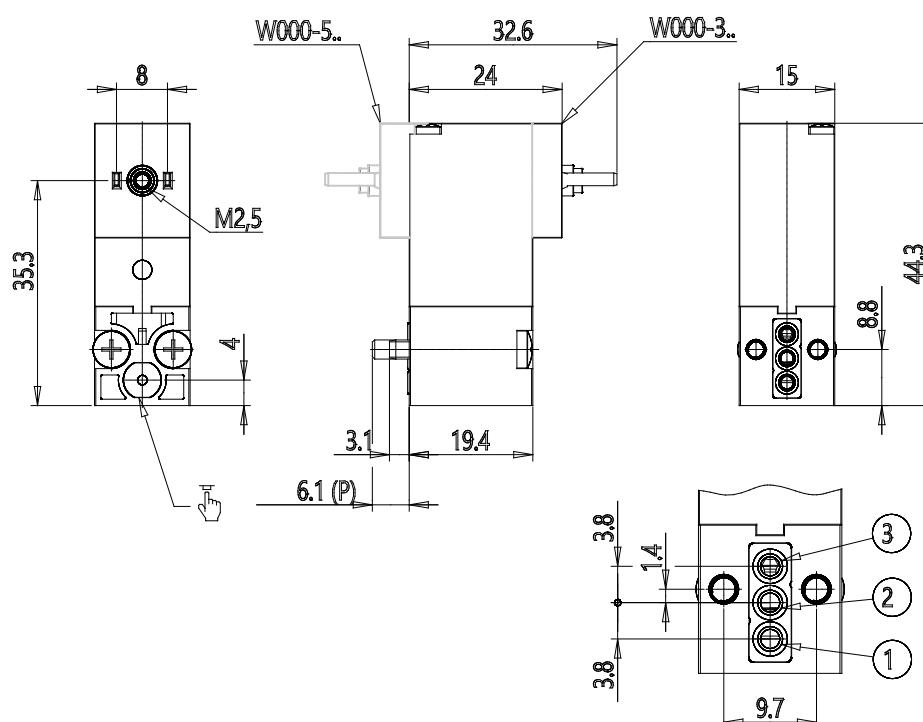

### DIMENSIONS

<b>Series</b>	W
<b>Body execution</b>	0 = interface
<b>Number of seats</b>	00 = ISO 15218 interface
<b>Number of ways - Functions</b>	3 = 3/2 way - NC
<b>Valve connections</b>	0 = ISO 15218 interface
<b>Orifice diameter</b>	5 = $\varnothing$ 1.1 mm
<b>Materials</b>	W = PBT body - NBR - FKM - PU seals
<b>Electrical connection</b>	2 = 12 V DC - 2 W (1 W only for NC - $\varnothing$ 0.8 mm version)
<b>Voltage - Absorbed power</b>	4 = 48 V DC - 2 W
<b>Fixing</b>	= fixing screws for metal
<b>Options</b>	= Standard