

## Mod. W7550 OX1 - Fittings Series 7000 - Medical

Product code: W7550 6-OX1

Datasheet creation date: 10/03/2025 09:18

Check the most updated document online [click here](#)



### ■ TECHNICAL DATA

Mod.	W7550 6-OX1
------	-------------

## Mod. W7550 OX1 - Fittings Series 7000 - Medical

Product code: W7550 6-OX1

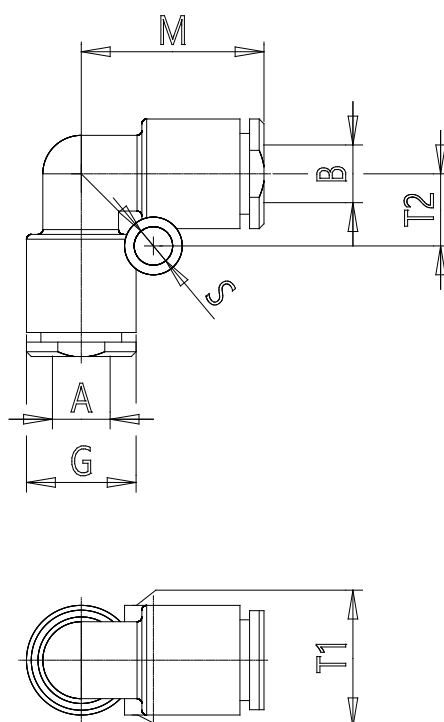

### DIMENSIONS

<b>A (mm)</b>	6
<b>B (mm)</b>	6
<b>G (mm)</b>	11.4
<b>M (mm)</b>	19.0
<b>S (mm)</b>	4
<b>T1 (mm)</b>	11.4
<b>T2 (mm)</b>	7.5
<b>Weight (g)</b>	6