

Mod. W7560 OX1 - Fittings Series 7000 - Medical

Product code: W7560 4-OX1

Datasheet creation date: 10/03/2025 09:18

Check the most updated document online [click here](#)



■ TECHNICAL DATA

Mod.	W7560 4-OX1
------	-------------

Mod. W7560 OX1 - Fittings Series 7000 - Medical

Product code: W7560 4-OX1

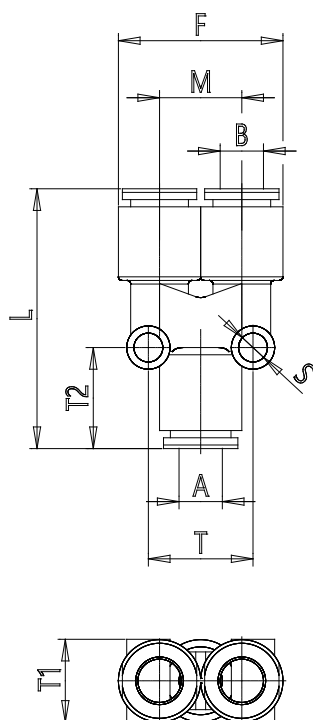

DIMENSIONS

A (mm)	4
B (mm)	4
E (mm)	19.7
F (mm)	18.2
H (mm)	7.5
L (mm)	33.2
M (mm)	9.0
S (mm)	4
T (mm)	10.8
T1 (mm)	9.5
T2 (mm)	13
Weight (g)	6