

Mod. X1510 - Series X2000 fittings

Product code: X1510 10/8-3/8

Datasheet creation date: 10/03/2025 08:54

Check the most updated document online [click here](#)



■ TECHNICAL DATA

Mod.	X1510 10/8-3/8
------	----------------

Mod. X1510 - Series X2000 fittings

Product code: X1510 10/8-3/8

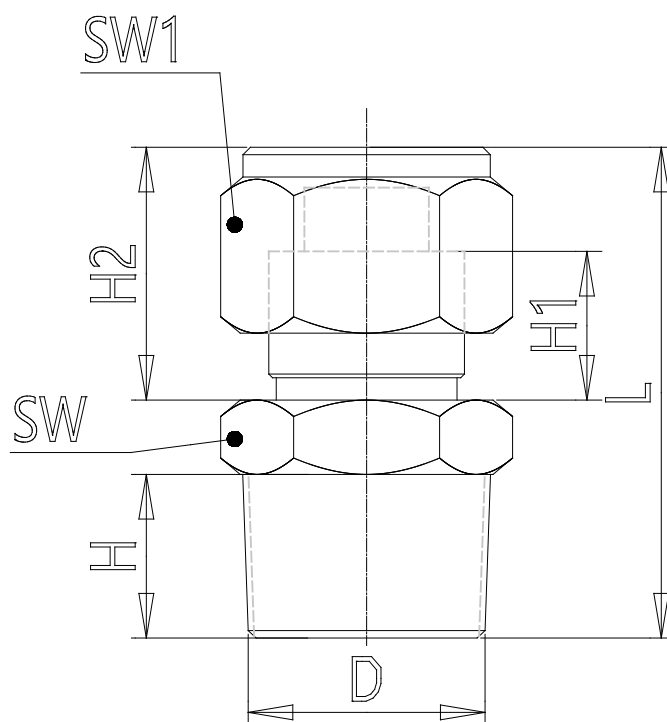

DIMENSIONS

Tube	10/8
D	R3/8
H (mm)	10.0
H1 (mm)	9
H2 (mm)	17.5
L (mm)	33
SW (mm)	17
SW1 (mm)	17