

## Mod. X1510 - Series X2000 fittings

Product code: X1510 8/6-1/4

Datasheet creation date: 10/03/2025 08:54

Check the most updated document online [click here](#)



### ■ TECHNICAL DATA

Mod.	X1510 8/6-1/4
------	---------------

## Mod. X1510 - Series X2000 fittings

Product code: X1510 8/6-1/4

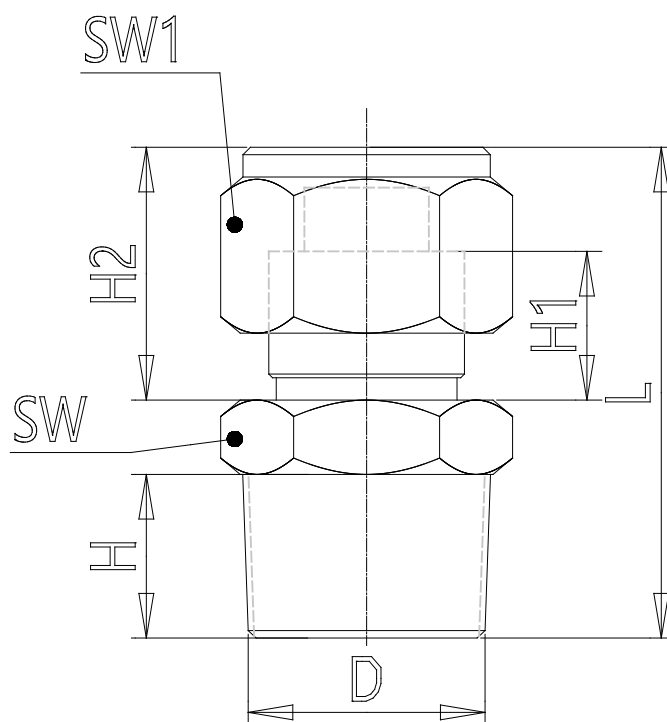

### DIMENSIONS

Tube	8/6
D	R1/4
H (mm)	10.0
H1 (mm)	8
H2 (mm)	16.0
L (mm)	32
SW (mm)	14
SW1 (mm)	14