

Mod. X2520 - Series X2000 fittings

Product code: X2520 1/4-1/2

Datasheet creation date: 10/03/2025 02:55

Check the most updated document online [click here](#)



■ TECHNICAL DATA

Mod.	X2520 1/4-1/2
------	---------------

Mod. X2520 - Series X2000 fittings

Product code: X2520 1/4-1/2

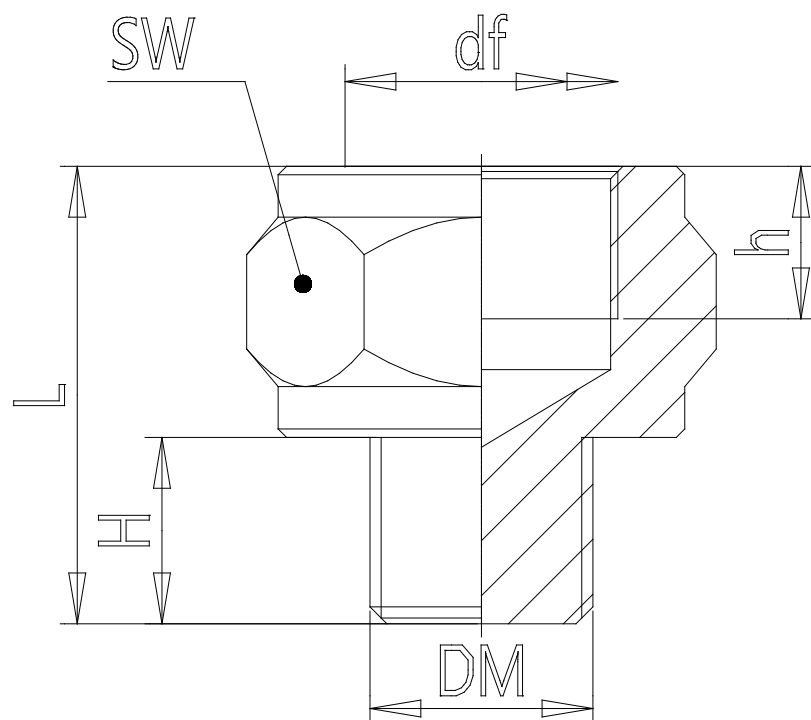

DIMENSIONS

DM	G1/4
df	G1/2
H (mm)	11
h (mm)	14
L (mm)	29
SW (mm)	27