

Mod. X2530 - Series X2000 fittings

Product code: X2530 1/2PT-3/8PT

Datasheet creation date: 10/03/2025 02:55

Check the most updated document online [click here](#)



■ TECHNICAL DATA

Mod.	X2530 1/2PT-3/8PT
------	-------------------

Mod. X2530 - Series X2000 fittings

Product code: X2530 1/2PT-3/8PT

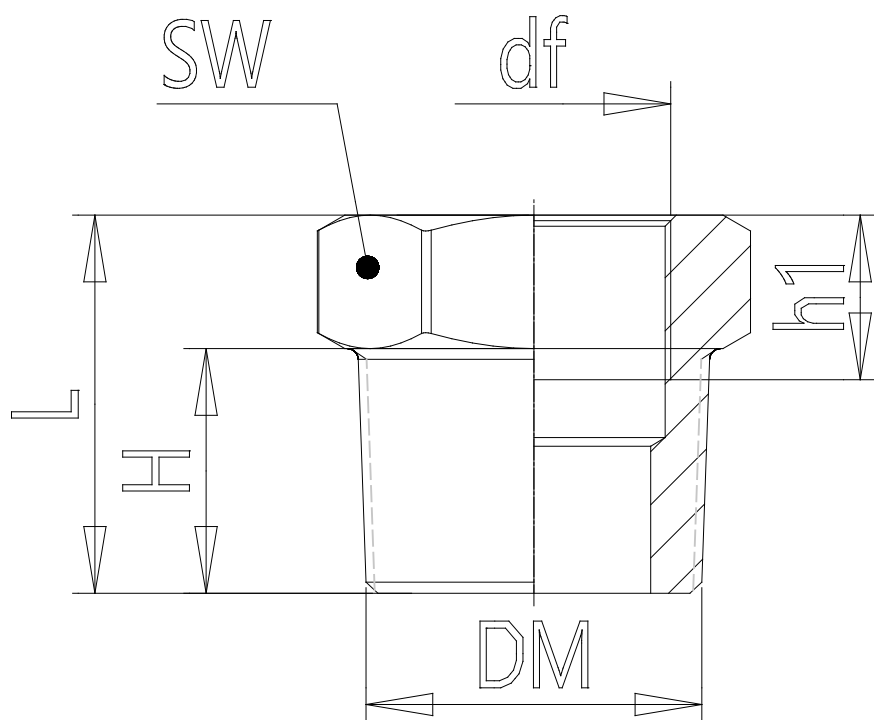

DIMENSIONS

D	1/2NPT
d	3/8NPT
H (mm)	14.0
h (mm)	13.0
L (mm)	20.0
SW (mm)	22