

Mod. X2530 - Series X2000 fittings

Product code: X2530 1/4-1/8

Datasheet creation date: 10/03/2025 02:55

Check the most updated document online [click here](#)



■ TECHNICAL DATA

Mod.	X2530 1/4-1/8
------	---------------

Mod. X2530 - Series X2000 fittings

Product code: X2530 1/4-1/8

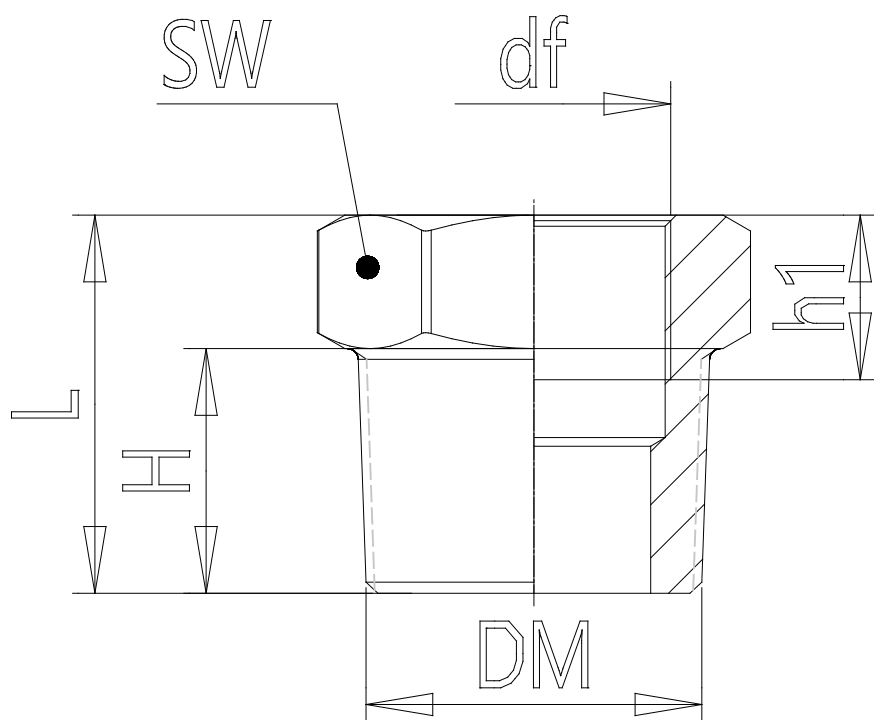

DIMENSIONS

D	R1/4
d	G1/8
H (mm)	10.0
h (mm)	7.0
L (mm)	16.0
SW (mm)	14