

Mod. X2530 - Series X2000 fittings

Product code: X2530 1/4PT-1/4

Datasheet creation date: 10/03/2025 02:55

Check the most updated document online [click here](#)



■ TECHNICAL DATA

Mod.	X2530 1/4PT-1/4
------	-----------------

Mod. X2530 - Series X2000 fittings

Product code: X2530 1/4PT-1/4

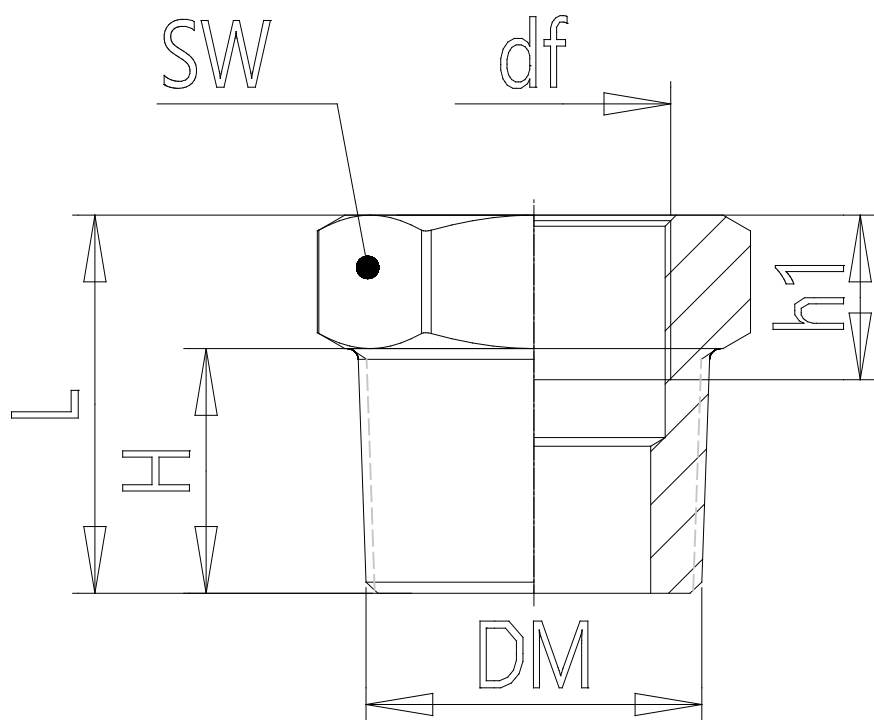

DIMENSIONS

D	R1/4
d	1/4NPT
H (mm)	15.0
h (mm)	12.5
L (mm)	28.5
SW (mm)	17