

Mod. X2530 - Series X2000 fittings

Product code: X2530 1/8-1/8PT

Datasheet creation date: 10/03/2025 02:55

Check the most updated document online [click here](#)



■ TECHNICAL DATA

Mod.	X2530 1/8-1/8PT
------	-----------------

Mod. X2530 - Series X2000 fittings

Product code: X2530 1/8-1/8PT

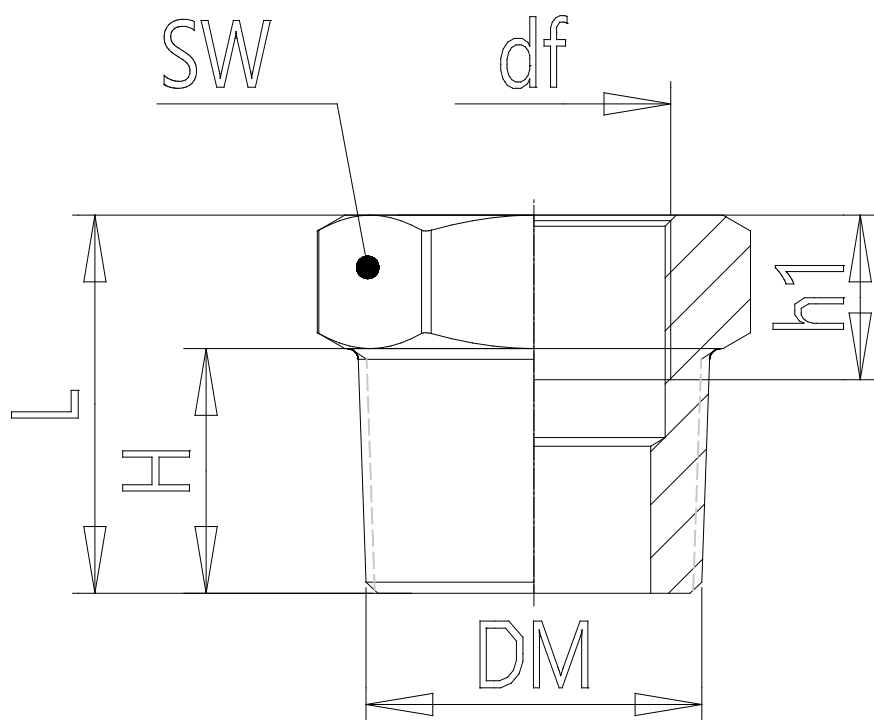

DIMENSIONS

D	1/8NPT
d	G1/8
H (mm)	11.0
h (mm)	7.5
L (mm)	21.5
SW (mm)	14