

Mod. X2530 - Series X2000 fittings

Product code: X2530 3/4-1/2

Datasheet creation date: 10/03/2025 02:55

Check the most updated document online [click here](#)



■ TECHNICAL DATA

Mod.	X2530 3/4-1/2
------	---------------

Mod. X2530 - Series X2000 fittings

Product code: X2530 3/4-1/2

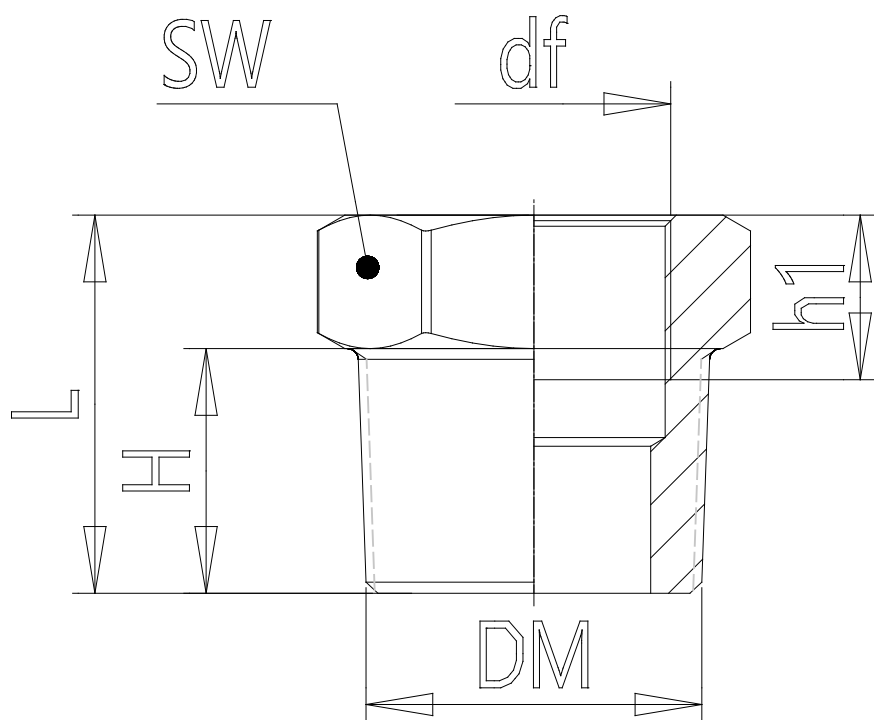

DIMENSIONS

D	R3/4
d	G1/2
H (mm)	17.0
h (mm)	14.0
L (mm)	23.0
SW (mm)	27