

Mod. X2530 - Series X2000 fittings

Product code: X2530 3/8-1/4

Datasheet creation date: 10/03/2025 02:55

Check the most updated document online [click here](#)



■ TECHNICAL DATA

Mod.	X2530 3/8-1/4
------	---------------

Mod. X2530 - Series X2000 fittings

Product code: X2530 3/8-1/4

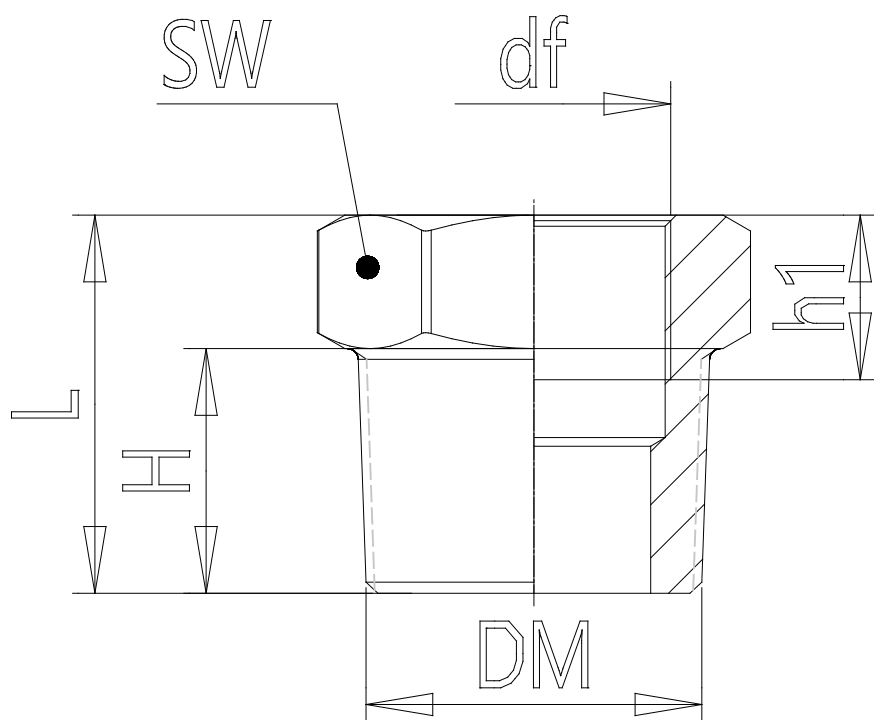

DIMENSIONS

D	R3/8
d	G1/4
H (mm)	11.0
h (mm)	10.0
L (mm)	17.0
SW (mm)	17