

Mod. X2530 - Series X2000 fittings

Product code: X2530 3/8-1/8

Datasheet creation date: 10/03/2025 02:55

Check the most updated document online [click here](#)



■ TECHNICAL DATA

Mod.	X2530 3/8-1/8
------	---------------

Mod. X2530 - Series X2000 fittings

Product code: X2530 3/8-1/8

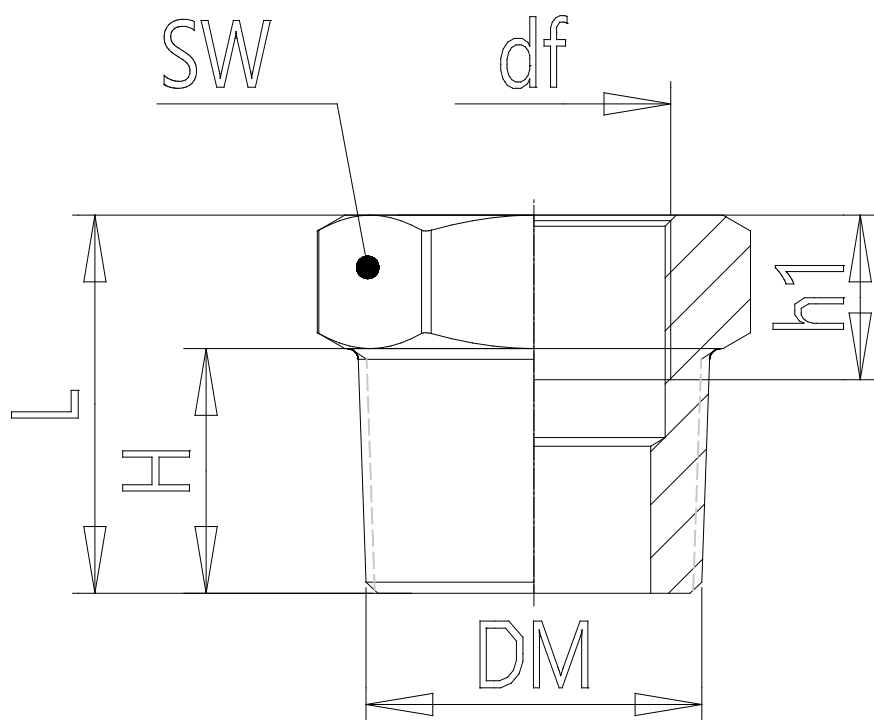

DIMENSIONS

D	R3/8
d	G1/8
H (mm)	10.5
h (mm)	8.0
L (mm)	17.0
SW (mm)	17