

## Mod. X2530 - Series X2000 fittings

Product code: X2530 3/8PT-1/8PT

Datasheet creation date: 10/03/2025 02:55

Check the most updated document online [click here](#)



### ■ TECHNICAL DATA

Mod.	X2530 3/8PT-1/8PT
------	-------------------

## Mod. X2530 - Series X2000 fittings

Product code: X2530 3/8PT-1/8PT

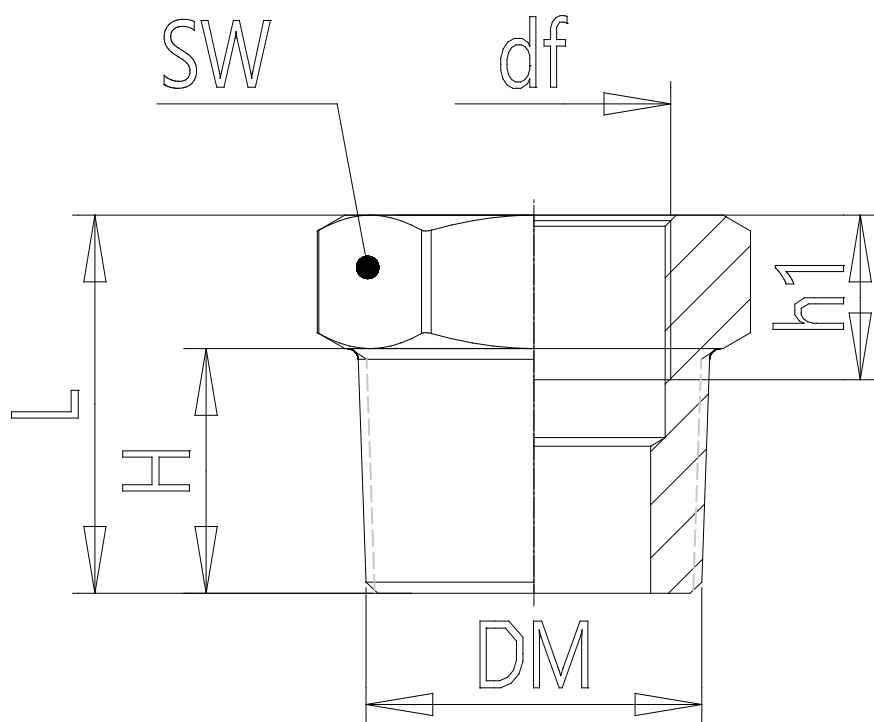

### DIMENSIONS

<b>D</b>	3/8NPT
<b>d</b>	1/8NPT
<b>H (mm)</b>	11.0
<b>h (mm)</b>	7.0
<b>L (mm)</b>	17.0
<b>SW (mm)</b>	19