

Mod. X2530 - Series X2000 fittings

Product code: X2530 3/8PT-3/8

Datasheet creation date: 10/03/2025 02:55

Check the most updated document online [click here](#)



■ TECHNICAL DATA

Mod.	X2530 3/8PT-3/8
------	-----------------

Mod. X2530 - Series X2000 fittings

Product code: X2530 3/8PT-3/8

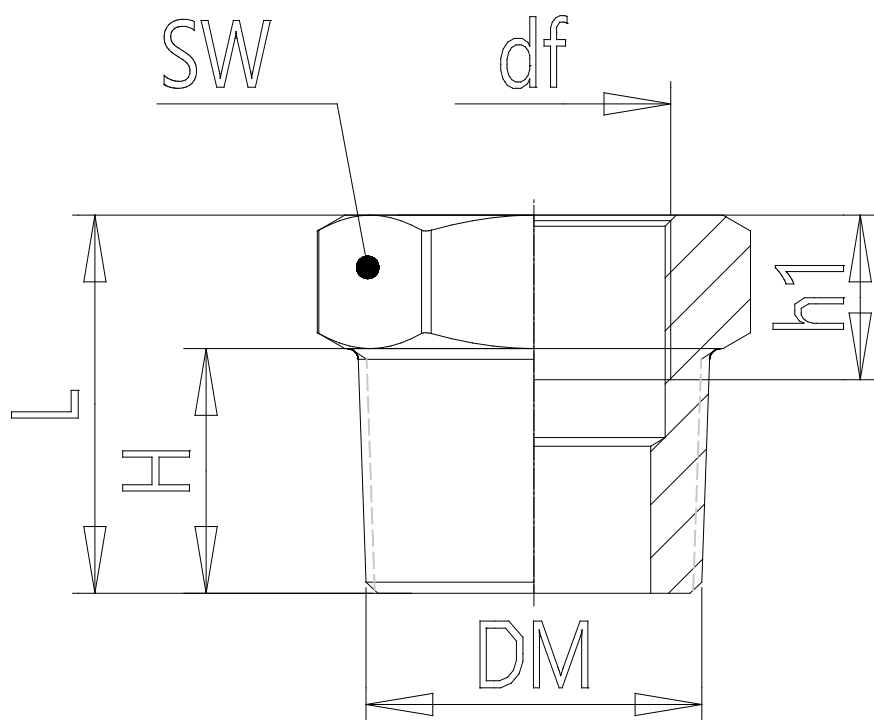

DIMENSIONS

D	R3/8
d	3/8NPT
H (mm)	16.0
h (mm)	12.0
L (mm)	29.5
SW (mm)	22