

Mod. X6512 - Series X6000 fittings

Product code: X6512 10-3/8

Datasheet creation date: 10/03/2025 09:20

Check the most updated document online [click here](#)



■ TECHNICAL DATA

Mod.	X6512 10-3/8
------	--------------

Mod. X6512 - Series X6000 fittings

Product code: X6512 10-3/8

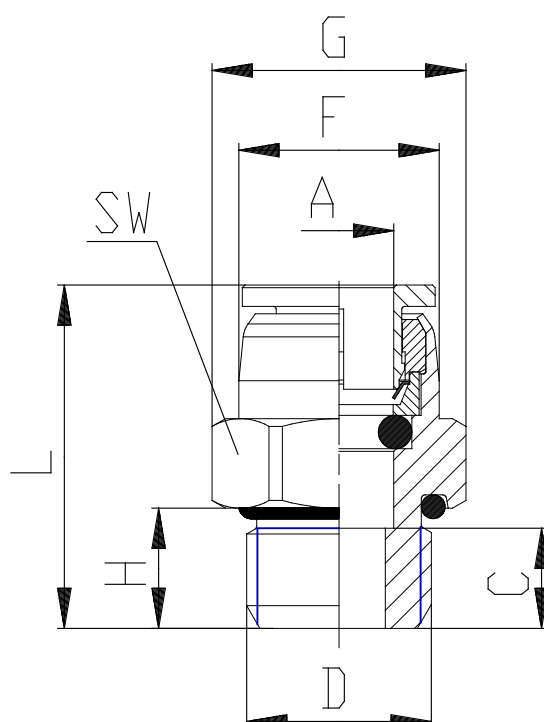

DIMENSIONS

A (mm)	10
C (mm)	6.5
D (mm)	G3/8
F (mm)	17.4
H (mm)	6.5
L (mm)	23.7
SW (mm)	22
Weight (g)	29
package	10