

Mod. X6512 - Series X6000 fittings

Product code: X6512 12-3/8

Datasheet creation date: 10/03/2025 09:20

Check the most updated document online [click here](#)



TECHNICAL DATA

Mod.	X6512 12-3/8
------	--------------

Mod. X6512 - Series X6000 fittings

Product code: X6512 12-3/8

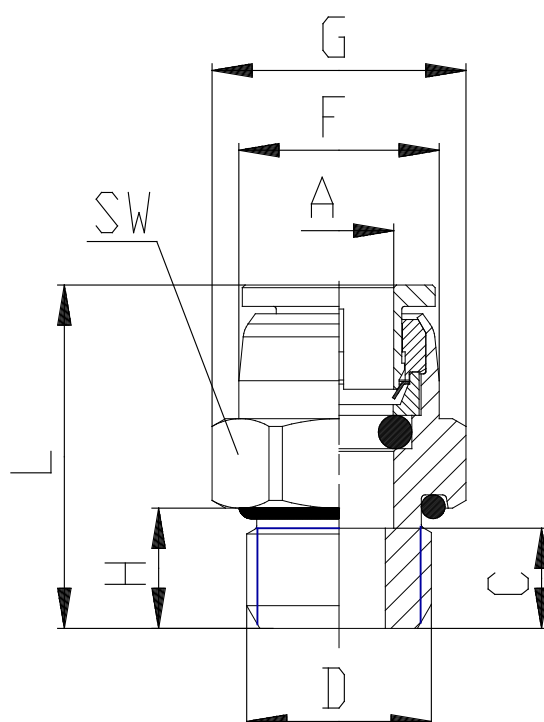

DIMENSIONS

A (mm)	12
C (mm)	9.0
D (mm)	G3/8
F (mm)	20.0
H (mm)	6.5
L (mm)	28.0
SW (mm)	22
Weight (g)	42
package	10