

Mod. X6590 - Series X6000 fittings

Product code: X6590 10

Datasheet creation date: 10/03/2025 09:22

Check the most updated document online [click here](#)



TECHNICAL DATA

Mod.	X6590 10
------	----------

Mod. X6590 - Series X6000 fittings

Product code: X6590 10

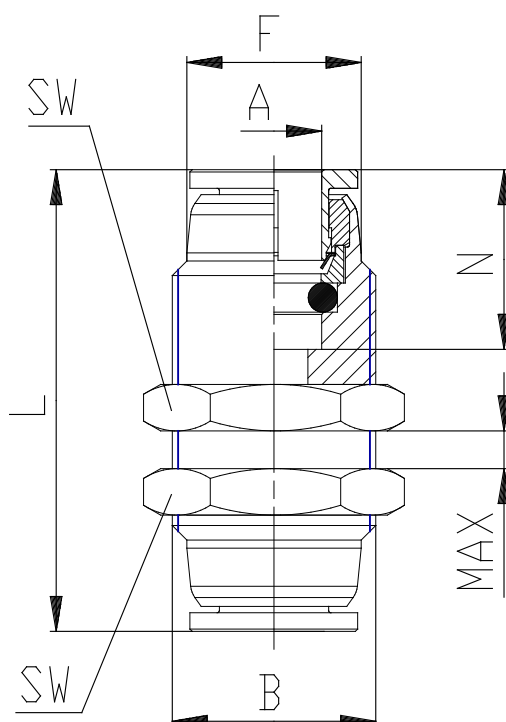

DIMENSIONS

A (mm)	10
B (mm)	M19X1
F (mm)	17.4
L (mm)	42.0
N (mm)	17.0
SW (mm)	22
Weight (g)	62
package	10