

Mod. X6590 - Series X6000 fittings

Product code: X6590 4

Datasheet creation date: 10/03/2025 09:22

Check the most updated document online [click here](#)



TECHNICAL DATA

Mod.	X6590 4
------	---------

Mod. X6590 - Series X6000 fittings

Product code: X6590 4

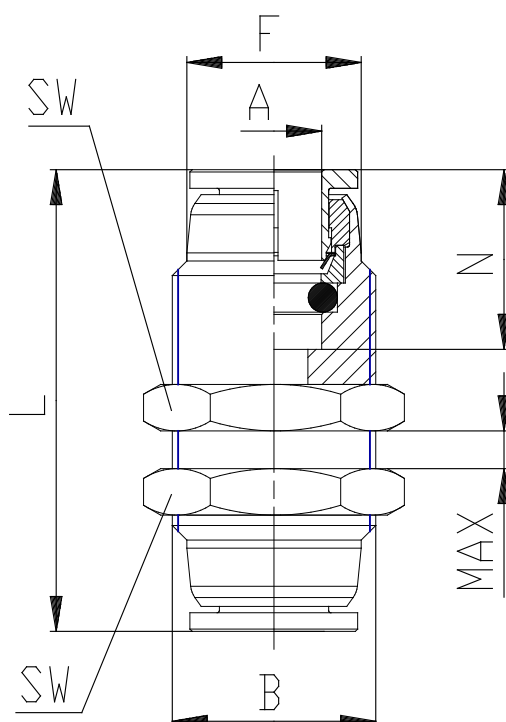

DIMENSIONS

A (mm)	4
B (mm)	M11X1
F (mm)	9.7
L (mm)	29.0
N (mm)	12.5
SW (mm)	14
Weight (g)	17
package	10