

Cilindros rotativos - Serie 69

Código de producto: 69-032/360-M

Fecha de creación de la hoja de datos: 26/05/26

Consulte el documento más actualizado en [haga clic](#)



DATOS TÉCNICOS

Serie	69
Diámetro (mm)	32
Вращение (°)	360
Piñón	M=piñón macho
Material juntas	= NBR

Cilindros rotativos - Serie 69

Código de producto: 69-032/360-M

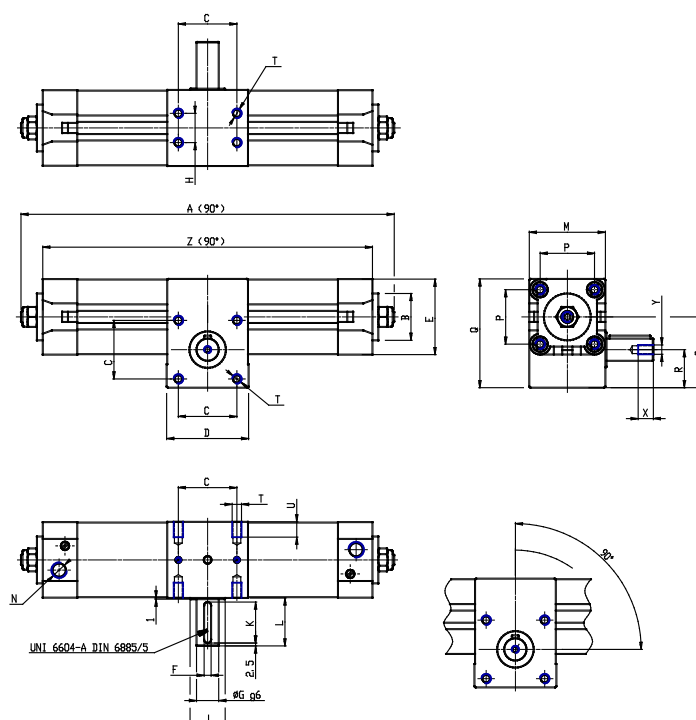

DIMENSIONES

A (mm)	390.0
B d11 (mm)	30
C (mm)	33
D (mm)	50
E (mm)	46.0
F (mm)	5
G (mm)	14
H (mm)	18
J (mm)	25
K (mm)	25
L (mm)	31
M (mm)	50
N	G1/8
P (mm)	32.5
Q (mm)	71.5
R (mm)	25.0
S (mm)	46.5
T	M6
U (mm)	10
V (mm)	16.3
W (mm)	14
Y	M5
X (mm)	12.5
Z (mm)	360.0