

Adaptador autocompensatorio - Mod. CF-50

Código de producto: CF-50-25

Fecha de creación de la hoja de datos: 27/05/26

Consulte el documento más actualizado en [haga clic](#)



DATOS TÉCNICOS

Mod.	CF-50-25
------	----------

Adaptador autocompensatorio - Mod. CF-50

Código de producto: CF-50-25

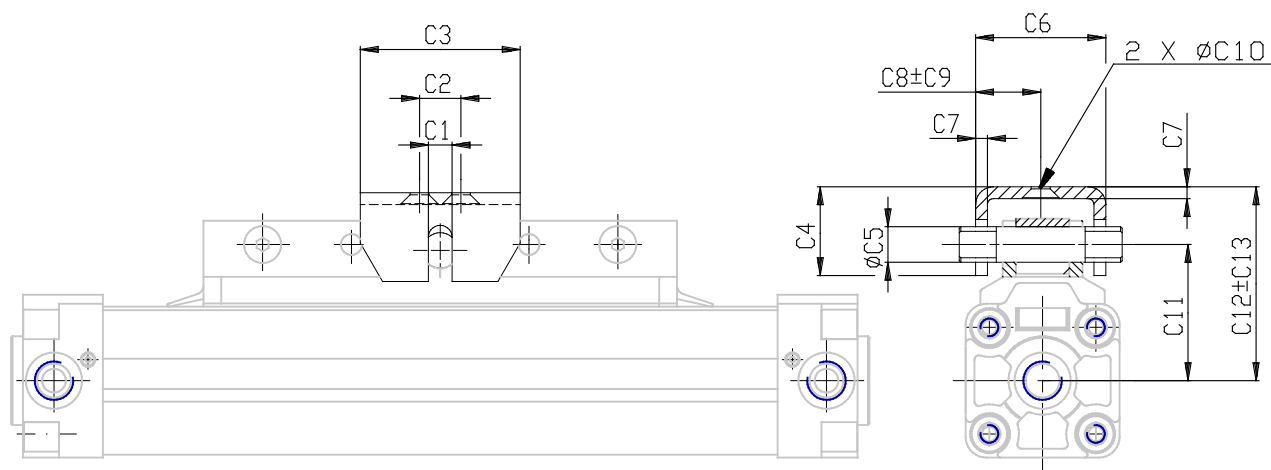

DIMENSIONES

C1 (mm)	6.0
C2 (mm)	16
C3 (mm)	40.8
C4 (mm)	22.9
C5 (mm)	7.9
C6 (mm)	31.5
C7 (mm)	3.0
C8 (mm)	15.8
C9 (mm)	1.2
C10 (mm)	5.6
C11 (mm)	38
C12 (mm)	55.4
C13 (mm)	4.5