

Subbase - Serie CP-CPN

Código de producto: CP-S7

Fecha de creación de la hoja de datos: 27/05/26

Consulte el documento más actualizado en [haga clic](#)



DATOS TÉCNICOS

Mod.	CP-S7
------	-------

Subbase - Serie CP-CPN

Código de producto: CP-S7

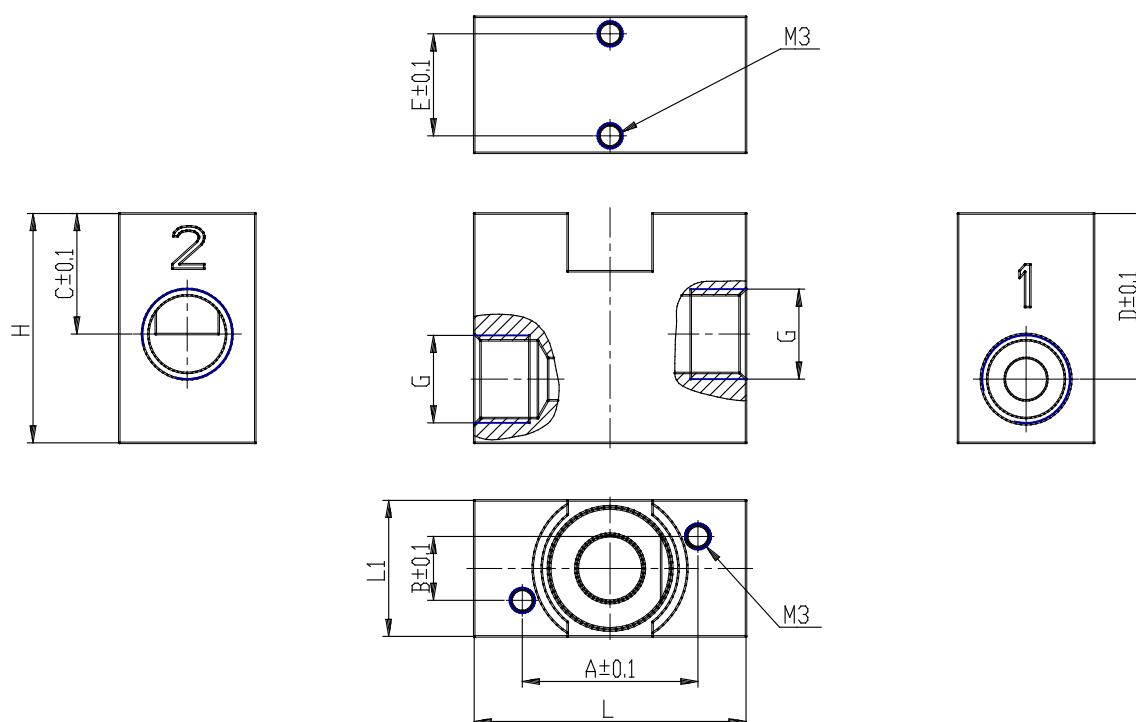

DIMENSIONES

A (mm)	25.20
B (mm)	8.00
C (mm)	14.0
D (mm)	22.5
E (mm)	15
G (mm)	1/4 G
H (mm)	31.5
L (mm)	45
L1 (mm)	22