

Charnela int. - Mod. F_6PF

Código de producto: F-61-125

Fecha de creación de la hoja de datos: 26/05/26

Consulte el documento más actualizado en [haga clic](#)



DATOS TÉCNICOS

Mod.	F-61-125
------	----------

Charnela int. - Mod. F_6PF

Código de producto: F-61-125

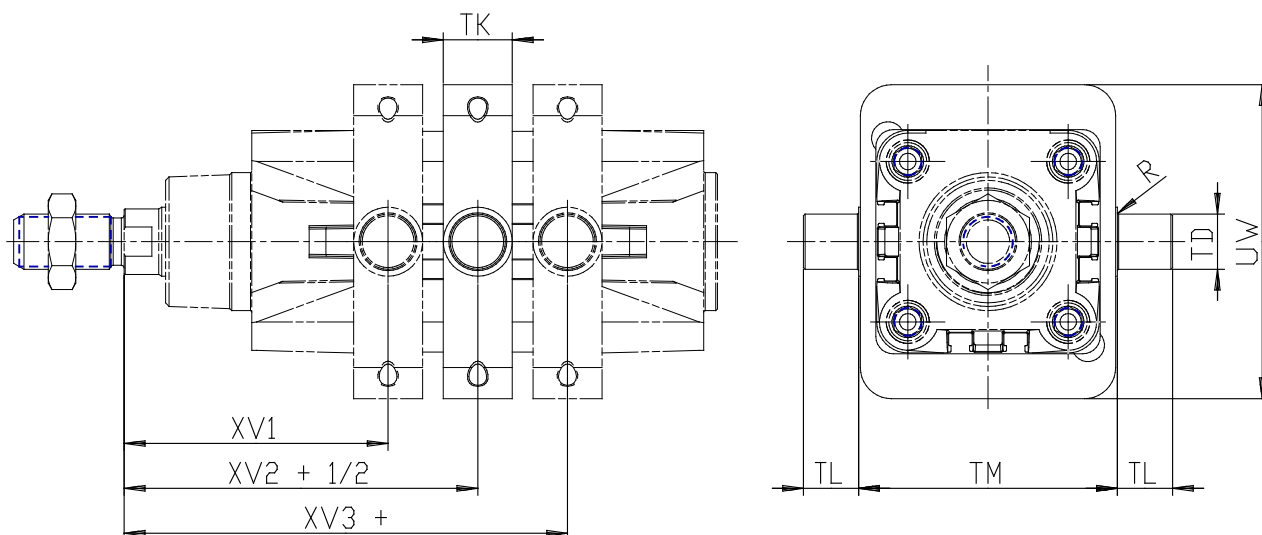

DIMENSIONES

XV1 (mm)	123.0
XV2 (mm)	145.0
XV3 (mm)	167.0
TM (mm)	160
TK (mm)	30
TD (mm)	25
TL (mm)	25
UW (mm)	155
R (mm)	0.20