

Amarre de charnela intermedia - Mod. I

Código de producto: I-12-16

Fecha de creación de la hoja de datos: 26/05/26

Consulte el documento más actualizado en [haga clic](#)



DATOS TÉCNICOS

Mod.	I-12-16
------	---------

Amarre de charnela intermedia - Mod. I

Código de producto: I-12-16

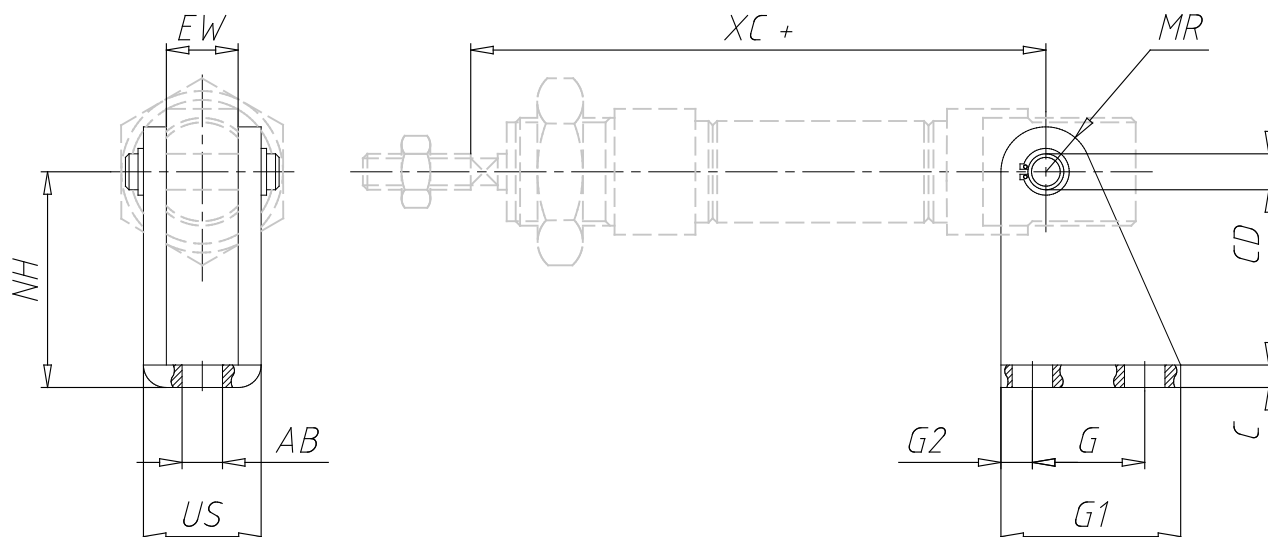

DIMENSIONES

G1 (mm)	25
G (mm)	15.0
G2 (mm)	5.0
CD (mm)	6
AB (mm)	5.5
C (mm)	3.0
NH (mm)	27
EW (mm)	12
US (mm)	18.1
MR (mm)	7.0
XC (mm)	75 - 82