

## Amarre con charnela post. - Mod. I

Código de producto: I-42-32

Fecha de creación de la hoja de datos: 26/05/26

Consulte el documento más actualizado en [haga clic](#)

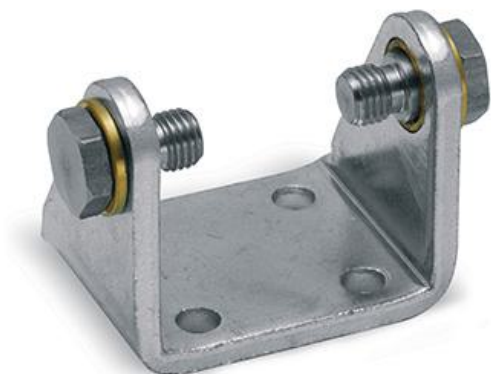

### **DATOS TÉCNICOS**

Mod.	I-42-32
------	---------

## Amarre con charnela post. - Mod. I

Código de producto: I-42-32

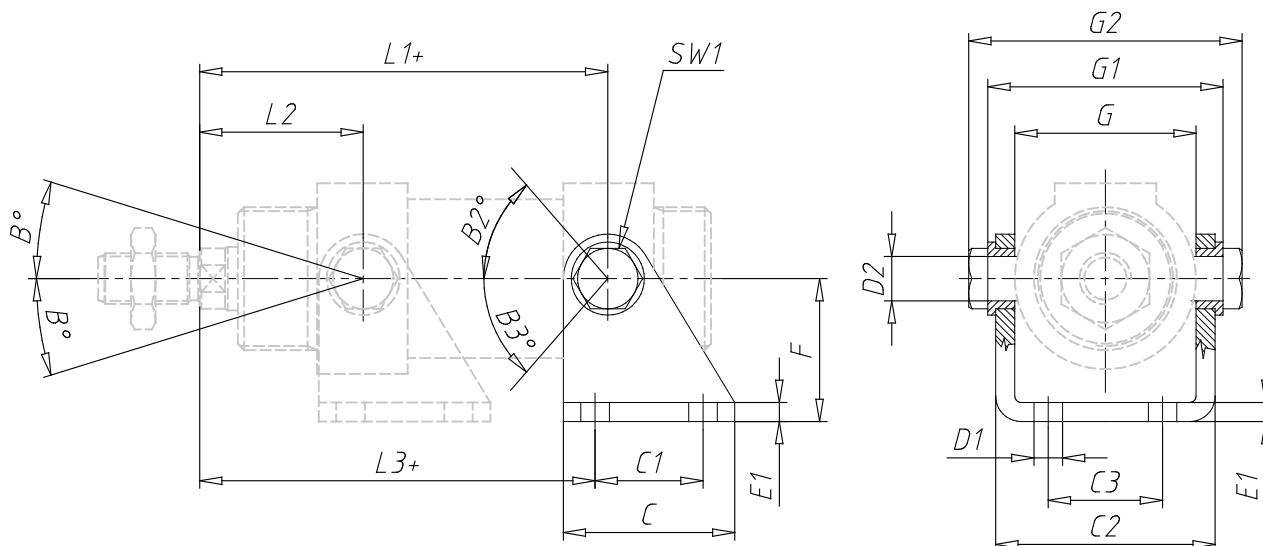

### DIMENSIONES

<b>L1 (mm)</b>	109.5
<b>L2 (mm)</b>	36.5
<b>L3 (mm)</b>	105.5
<b>C (mm)</b>	40
<b>C1 (mm)</b>	24
<b>C2 (mm)</b>	46.1
<b>C3 (mm)</b>	20
<b>D1 (mm)</b>	7
<b>D2 (mm)</b>	10
<b>E1 (mm)</b>	4
<b>F (mm)</b>	35
<b>SW1 (mm)</b>	13
<b>G (mm)</b>	38.1
<b>G1 (mm)</b>	50.1
<b>G2 (mm)</b>	58.1