

## Amarre con charnela post. - Mod. I

Código de producto: I-42-40

Fecha de creación de la hoja de datos: 26/05/26

Consulte el documento más actualizado en [haga clic](#)

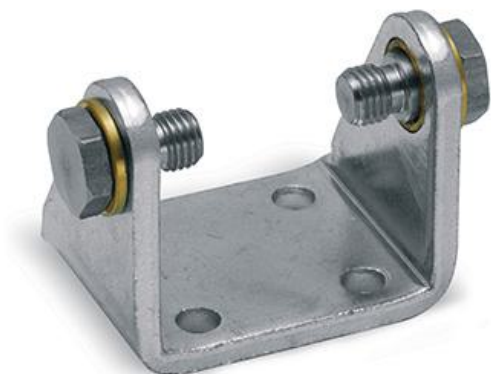

### **DATOS TÉCNICOS**

Mod.	I-42-40
------	---------

## Amarre con charnela post. - Mod. I

Código de producto: I-42-40

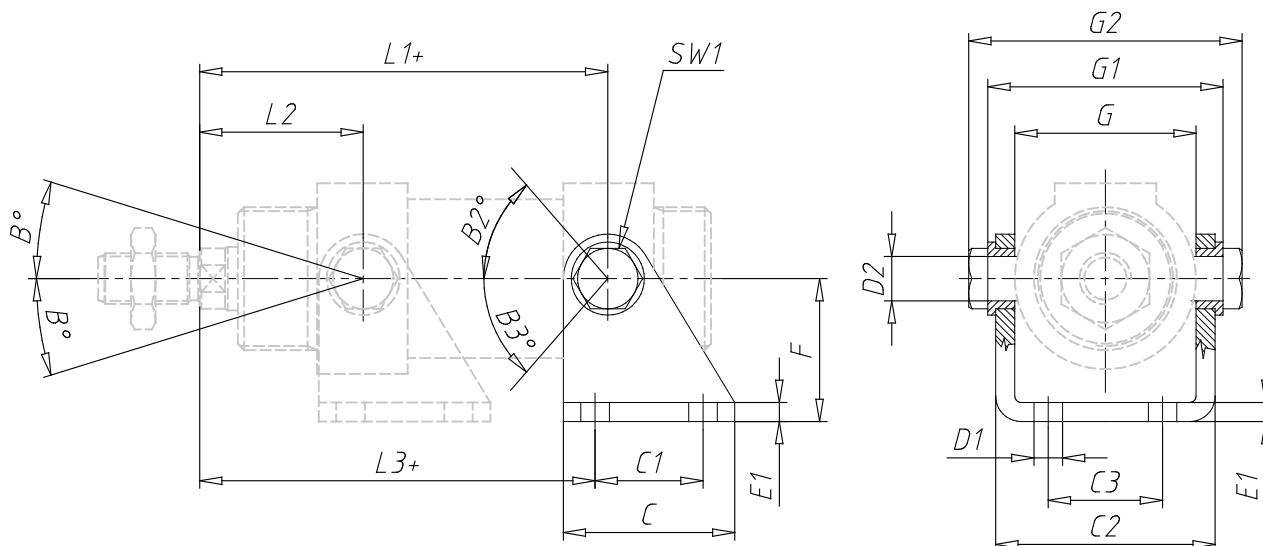

### DIMENSIONES

<b>L1 (mm)</b>	120.0
<b>L2 (mm)</b>	45.0
<b>L3 (mm)</b>	117.0
<b>C (mm)</b>	50
<b>C1 (mm)</b>	30
<b>C2 (mm)</b>	56.1
<b>C3 (mm)</b>	28
<b>D1 (mm)</b>	9
<b>D2 (mm)</b>	12
<b>E1 (mm)</b>	5
<b>F (mm)</b>	40
<b>SW1 (mm)</b>	17
<b>G (mm)</b>	46.1
<b>G1 (mm)</b>	60.1
<b>G2 (mm)</b>	70.1