

Reguladores - Serie MC

Código de producto: MC104-R10

Fecha de creación de la hoja de datos: 26/05/26

Consulte el documento más actualizado en [haga clic](#)



DATOS TÉCNICOS

Mod.	MC104-R10
U	G1/4

Reguladores - Serie MC

Código de producto: MC104-R10

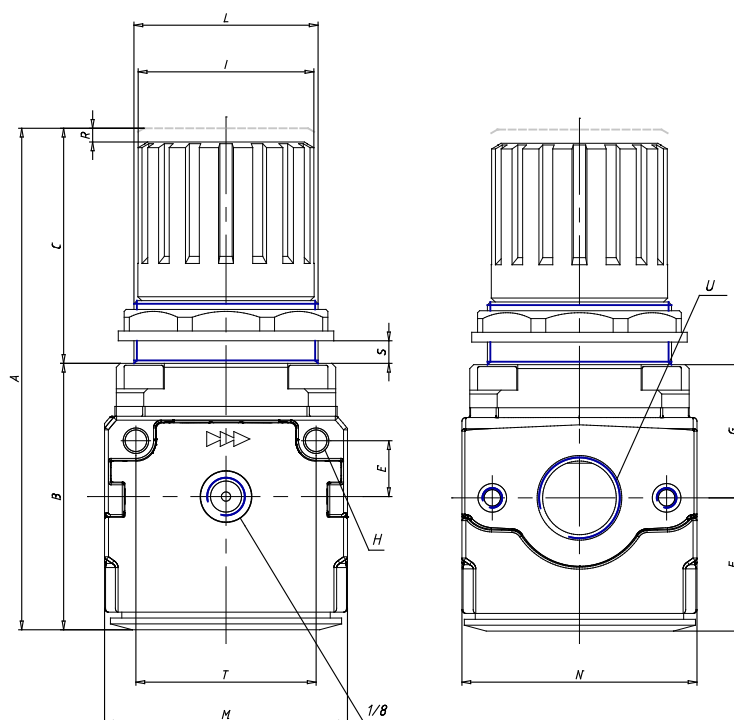

DIMENSIONES

A (mm)	94
B (mm)	56
C (mm)	38
E (mm)	11
F (mm)	28.5
G (mm)	27.5
H (mm)	4.5
I (mm)	28
L	30x1.5
M (mm)	45
N (mm)	45
R (mm)	3.0
S	0:6
T (mm)	35